

Overview 2018



Cavanna is flowpack, Cavanna is cartoning.



Cavanna is flowpack, Cavanna is cartoning.

Index

Wrappers

ZeroZero Electronic wrapper.....	3
Zero 2 Electronic wrapper.....	5
Zero 4 wrapper.....	8
Zero 4 BRL wrapper.....	10
Zero 4 NKZ wrapper.....	11
Zero 5 wrapper.....	13
Zero 5 Box Motion wrapper.....	16
Zero 5 BRL wrapper.....	19
Zero 5 NKZ wrapper.....	20
Zero 5 R wrapper.....	22
Slim - Twin Slim wrapper.....	25
Zero X wrapper.....	28

Bakery Loaders

TND Loader.....	30
QF Loader.....	31
ESP Loader.....	32
SBF Loader.....	33
MAF Loader.....	34
TSL Loader.....	35
MDB Loader.....	36
Pi.Co. Loader.....	37

Confectionery Loaders

90° transversal belts loader.....	38
105°- 90° transversal belts loader.....	39
In-line "Stream" belt feeder.....	40
"CKDW" loader.....	41

Row Distribution

Row distribution System type "DR".....	42
Row distribution System type "SDR".....	43

Accessories

"TPC" cardboard dispenser from reels.....	44
Flap folding device.....	45
Vacuum Test System "VTS".....	46

Storage Management

Dynamic buffer "FIFO" type.....	47
Multi-level horizontal buffer "LIFO" type.....	48
DY-B Dynamic buffer.....	49

End Line Systems

Robotic Multipack System G41.....	51
G41 EFC.....	52
Robotic System P4.....	54
Cavanna vision guided robotic systems.....	55
CartEasy.....	57

ZeroZero Electronic wrapper

A highly technological wrapper for medium production speeds



Technical Specifications

- Weight: Kg. 1250
- Max reel width: mm 370 - 470
- Max. reel diameter: mm 350
- Height of reel holder axis: mm 1350 ± 50
- Max. reel weight: Kg. 30
- Useful length for the product loading: mm 2000
- Height of infeed and outfeed conveyors: mm 850 ± 50
- Color: RAL 1013
- Max. power supply: 8 kWA
- Mechanical speed: up to 200 ppm

Wrapping material

Heat or cold sealable material



Operator panel



ZeroZero wrapper



Gravity feeders



90° or 105° infeed belts

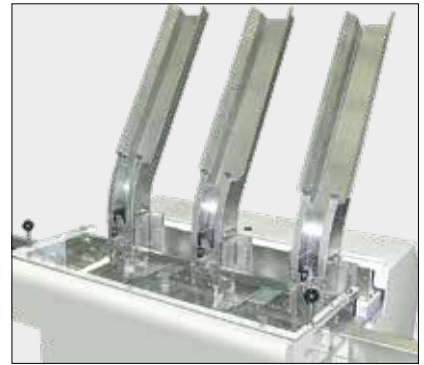

Loader "CA 43 - BR"

Minimum and maximum product dimensions*

- Length: 60 ÷ 300 mm
- Width: 15 ÷ 120 mm
- Height: 10 ÷ 80 mm

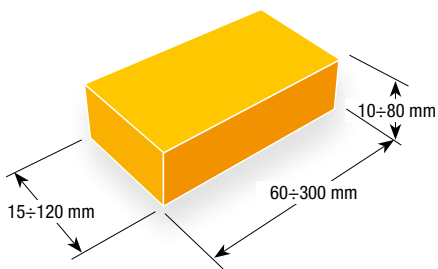
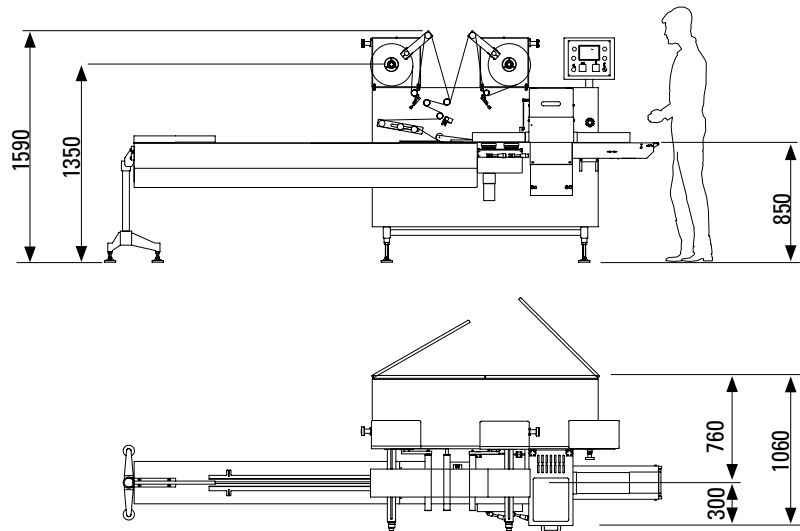
Line dimension

* Minimum and maximum dimensions do not coexist

The above-mentioned data aren't binding. We have the right to change the specifications of the products without notice.



Zero 2 Electronic wrapper

A highly technological wrapper for high production speeds



Type of machine

Electronic wrapping machine designed to meet the growing demand for rapid size change-overs, simple use and extremely easy maintenance.

Compact structure for minimum dimensions and maximum loading space. Types of loadings: manual, semiautomatic with automatic loaders.

Main Features

- Robust main frame built in stainless steel. The components are designed to allow an easy access and facilitate cleaning and maintenance
- Servomotors control the infeed chain, the longitudinal sealing units and transversal sealing units
- Minimum distance from floor mm. 330
- Adjustments: speed, cut-off length, reel centering and brake modulation during movement
- Automatic stop when the wrapping material is over
- Standard photocell to be used with print-centered film, with automatic search of sequence 180° forward and 180° reverse
- Brackets for code-dater fitment (not included)
- Independent temperature control of longitudinal and transversal sealing units
- Automatic opening of the longitudinal sealing wheels when the machine stops
- Regulable longitudinal flap folder
- Machine stops with jaws in open position
- Driven exit belt

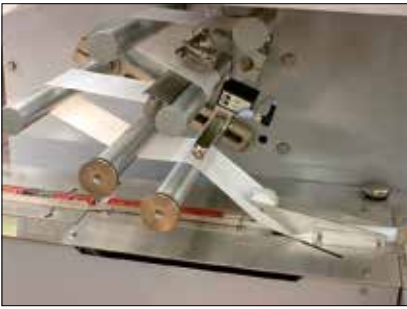

Wrapper Zero 2 Electronic

Longitudinal Sealing

Longitudinal Sealing

Transversal Sealing

Longitudinal Sealing

The first set of longitudinal sealing units is unheated and can be slanted to perfectly wrap the wrapping material around the product.

The second and third sets are heated and automatically open each time the machine stops.

The longitudinal flap is folded to the left or to the right by means of a fourth set of tapered sealing wheels.

Transversal Sealing

Robust frame, the gears with gap take-up provide perfect sealings by means of jaws with transversal groovings.

The unit allows the fitment of single or double jaws, manufactured in special steel to achieve speeds up to 800 packs/min. Distance between jaws is finely tuned to the height of the product.

Machine options

- Frame in stainless steel
- Multi-directional wheels
- Gravity feeders or automatic systems for products in piles
- Cross conveyor belts at 90° or 105°
- Automatic splicer
- Code-daters
- Chilling units for the longitudinal sealing area
- Vacuum system
- PLS gusseting device
- Double jaws
- Notch for easy opening
- Driven unwinding system
- Automatic infeed systems
- Reel width 670 mm

Operator Interface

Simple and easy, lets the operator check the machine settings of speed, temperature and print centering.

Operator Interface

Loader for products in piles

Lane reducing systems for automatic lines

Conveyor systems for automatic wrapping lines



Wrapping lines for singlepack and multipack



Cross conveyor belt at 105°

“PFS” loader for biscuits

Built in a robust frame, this horizontal loader with continuous movement is able to receive more than 400 biscuits per minute coming in one lane and form piles of 2 biscuits. Subsequently it forms portions made of 1 pile of 2 biscuits and 2 piles of 2 biscuits.



Minimum and maximum product dimensions*

- Length 35 ÷ 70 mm
- Width 35 ÷ 70 mm
- Height 5 ÷ 12 mm

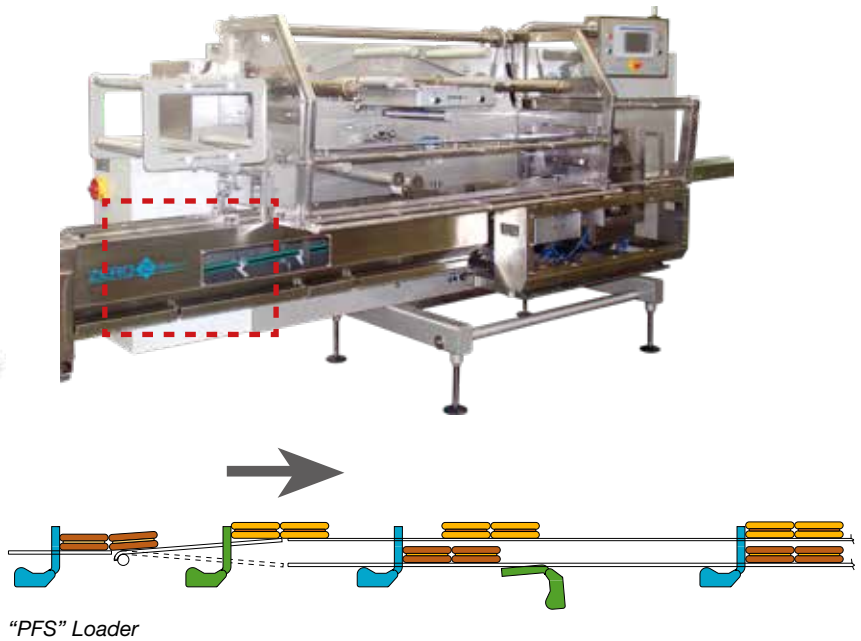

Technical specs

- Weight Kg 1850
- Maximum reel web mm 570
- Maximum reel diameter..... mm 400
- Height of reel holder axis mm 1340 +/- 50
- Maximum reel weight Kg. 40
- Useful product loading length mm 1500
- Infeed and discharge height..... mm 850 +/- 50
- Color RAL 9006
- Power required: 6 kVA
- Mechanical speed: up to 800 p.p.m.

Minimum and maximum product dimensions*

- Length 50 ÷ 550 mm
- Width 30 ÷ 160 mm
- Height 5 ÷ 120 mm

Dimensions

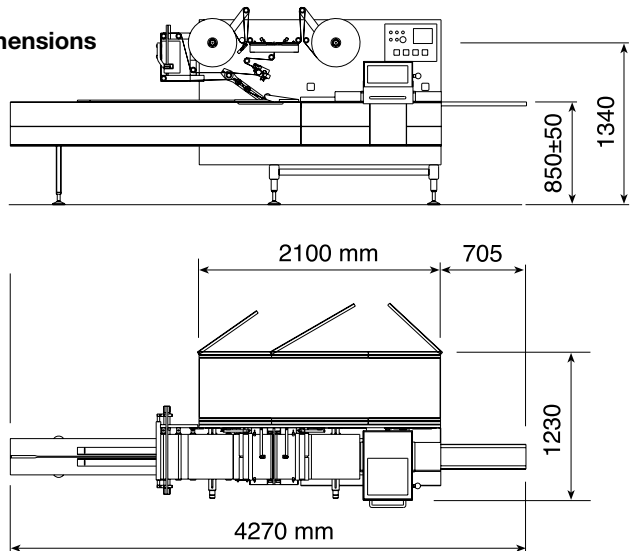

** Minimum and maximum dimensions do not coexist
The above-mentioned data aren't binding. We have the right to change the specifications of the products without notice.*

Wrapping material

Heat sealable or cold sealable material

Zero 4 wrapper

Flowpack wrapping platform dedicated to the medium speed segment



Type of machinery

Continuous motion horizontal packaging machine, maintenance free.

Speed

Specially designed to be included in the medium speed segment, the wrapper can reach 40 meters/min. with heatsealable materials. Higher speeds can be achieved with coldsealable materials.

The wrapper Zero4 belongs to the EZ4 Platform

Ez4 System is the Cavanna solution to the changing medium level market requirements, with even more care to the relationship "quality-price". We offer dedicated accessories, with full line capabilities to automatically package bakery products, snack bars, confectionary items, trays of product, and other frozen food products. EZ4 System is the Cavanna synthesis of five hundred wrappers manufactured in more than 50 years of presence in the flowpack world.

"Less is more" Systems were designed in an essential way, privileging functionality and easy maintenance.

Zero 4 wrapper



Ez4
SYSTEM
Less is more



Reel holder



Electrical cabinet

General features

- Cantilever design
- Painted body
- Four pairs of longitudinal sealing wheels:
 - first pair cold - swivelling
 - second pair hot
 - third pair cold (hot on demand)
 - fourth pair for longitudinal seal flap folding
- ALLEN BRADLEY® and/or ELAU® control electronics
- Three brushless motors for the control of the three basic function, infeed chain, drawing film and jaws
- Asynchronous motor for discharge belt drawing
- 6" colour touch screen HMI installed including: Start – Stop – Emergency - Reset
- Brackets for several kinds of code daters

- Available in the stainless steel version
- Fully washdown available

Wrapping material

Heat sealable or cold sealable material



Wrapper's chainless infeed for sticky products

Data sheet

Colour:Steel-it grey
 Height from ground:850 ±50 mm
 Height from ground reel-holder spindles:1485 mm
 Height from ground of any CAB table:1210 mm
 Length (excluding infeed):3.000 mm
 Width:1.150 mm
 Height:1.600 mm
 Reel width:370 mm / 570 mm
 Max reel diameter:400 mm
 Max speed:800 ppm
 film max speed:70 m/1'

Minimum and maximum product dimensions*

- Length 20 ÷ 600 mm
- Width 20 ÷ 200 mm
- Height 5 ÷ 80 mm

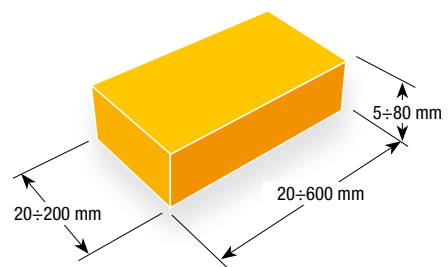

* Minimum and maximum dimensions do not coexist
 The above-mentioned data aren't binding. We have the right to change the specifications of the products without notice.



Zero 4 BRL wrapper

Electronic horizontal wrapper for middle speed applications for products in tray



Type of machinery

Continuous motion horizontal packaging machine, designed for wrapping products in tray.



Speed

Up to 200 ppm.

Wrapping material

Heat sealable or cold sealable material



Data sheet

Colour:Steel-it grey
 Height from ground:850 ±50 mm
 Height from ground reel-holder spindles:1485 mm
 Height from ground of any CAB table:1210 mm
 Length (excluding infeed):3.000 mm
 Width:1.150 mm
 Height:1.600 mm
 Reel width:370 mm / 570 mm
 Max reel diameter:.....300 mm
 Max speed:200 ppm
 Film max speed:45 m/1'

Minimum and maximum product dimensions*

- Length: 100 ÷ 350 mm
- Width: 40 ÷ 200 mm
- Height: 20 ÷ 70 mm

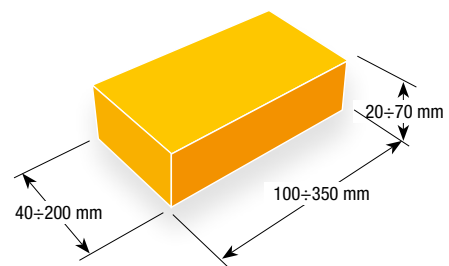

* Minimum and maximum dimensions do not coexist
 The above-mentioned data aren't binding. We have the right to change the specifications of the products without notice.

Zero 4 NKZ wrapper

Electronic wrapping machine for slug products



Type of machine

Horizontal continuous-motion wrapping machine for slug products. Conceived to appropriately meet the growing needs of fast format changes, it associates easy use and maintenance, low-cost operation and high performances.

Speed

Up to 100 ppm.

Main features

- Modular construction
- Tight control of the slugs at every stage of the operation

- Special devices adaptable for various product shapes
- Low maintenance level
- Lateral fingers for the optimal handling of the slug during the sealing phase
- Easy and fast changeover
- Friendly operating coloured touch-screen panel
- 99 sizes memory
- Automatic reel splicing
- No Product-No Bag function available option

Zero 4 NKZ wrapper





Transfer unit



Transversal jaws



Folding box and lateral fingers circuit



General features

- Sheet steel machine base, welded and painted
- Four pairs of longitudinal sealing wheels:
 - first pair cold - swivelling
 - second pair hot
 - third pair hot
 - fourth pair for longitudinal seal flap folding
- ELAU® or ALLEN BRADLEY® control electronics
- Four brushless motors for the control of the four basic function, infeed chain, drawing film, jaws and lateral fingers
- Asynchronous motor for discharge belt drawing
- 6" colour touch screen HMI installed including: Start – Stop – Emergency - Reset
- Brackets for several kinds of code daters

Wrapping material

Heat or cold sealable material

Data sheet

Colour:Steel-it grey
 Height from ground:1000 ±50 mm
 Height from ground reel-holder spindles:1635 mm
 Height from ground of any CAB table:1360 mm
 Length (excluding infeed):3.000 mm
 Width:1150 mm
 Height:1800 mm
 Reel width:570 mm
 Max reel diameter:.....300 mm
 Max speed:100 ppm
 Film max speed:35 m/1'

Minimum and maximum product dimensions*

- Length: 50 ÷ 180 mm
- Width: 30 ÷ 99 mm
- Height: 38 ÷ 80 mm
- Diameter: 35 ÷ 70 mm

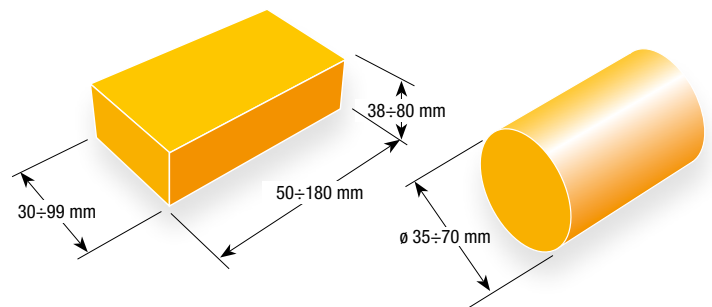

** Minimum and maximum dimensions do not coexist
 The above-mentioned data aren't binding. We have the right to change the specifications of the products without notice.*

Zero 5 wrapper

Electronic wrapping machine with semi-automatic or automatic feeding for high production speeds



Products to treat

Products with a fairly regular shape.
Biscuits. Crackers. Bars.
Non-food products.

Type of machine

Continuous motion horizontal packaging machine for wrapping products by using thermo-sealable and/or cold-sealable materials taken from reel. Designed to meet the growing demand for quick changeovers, it combines easy use and maintenance, low-cost operation and high performance.

Speed

Over 1000 paks per minute depending on the characteristics of the product to be wrapped and of the wrapping material being utilized. (Wrapping material linear speed up to ~120 m/min).

Main features

- Sturdy construction, with painted steel plates
- Monitor and keyboard easily accessible for quick data entry and prompt reading of packaging machine working conditions
- Password protection to prevent tampering by unauthorized personnel
- Diagnostics with help messages and troubleshooting
- Several languages are available for video-messages
- Graphic interface for easy learning and operation of the machine
- Graphic instructions to operator for changeover and manual adjustment of size parts
- Rockwell ControlLogix® or ELAU® control electronics.



Zero 5 wrapper

Reel-Holder

- Double reel-holder with oscillating braking system
- Option: automatic reel splicing without wrapper stop
- Max reel diameter: 400 mm
- Max reel-web: 570 mm
- Special version with reel-web up to 770 mm
- Height of reel-holder axis from floor: 1460 +/- 50 mm

Wrapping material print registration

- Fully automatic control by means of micro-processors, with 180° forward and backward automatic research
- Timing cam device to provide synchronous signals to fit other devices such as Coders, Labelling Machines, etc...

Equipment

- Electronic servomotor drive system to control infeed chain, longitudinal sealing wheels and transversal sealing and cutting unit
- 3 independent longitudinal sealing groups with driven flap folding unit
- Special long-dwell sealing units, for high tightness levels
- Transversal sealing unit installed on frame for quick removal in case of jaw change

Wrapping material

Heat or cold sealable material

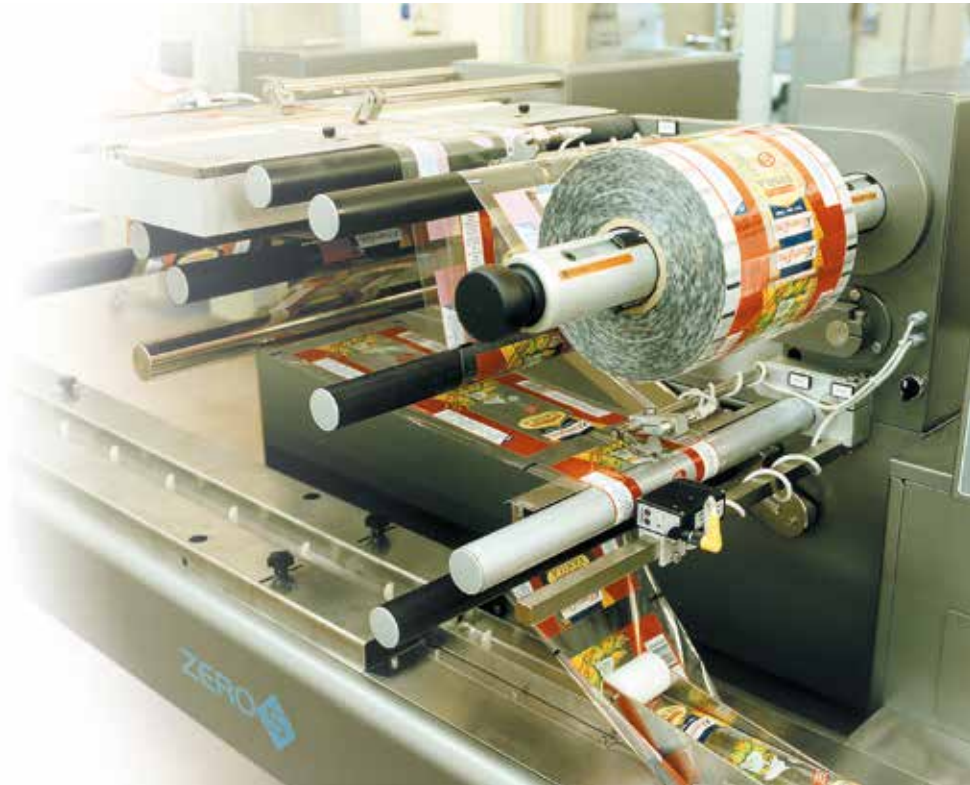

Reel holder with automatic splicing device

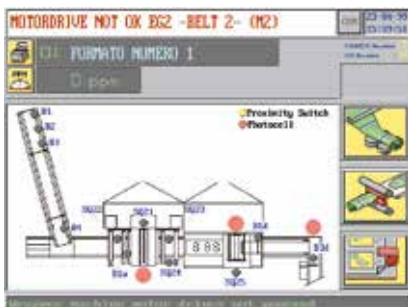

Touch-screen operator panel



Available options

- Powered unwinding roller
- Accompanying gusseting devices according to pack requirements
- Device to check empty, twin, not-registered packs and packs from reel splicer
- No-product no-bag function
- Cutless function (no-gap no-seal)
- Device to apply longitudinal or transversal tear tape
- Device to feed cardboard, taken from reel or magazine.

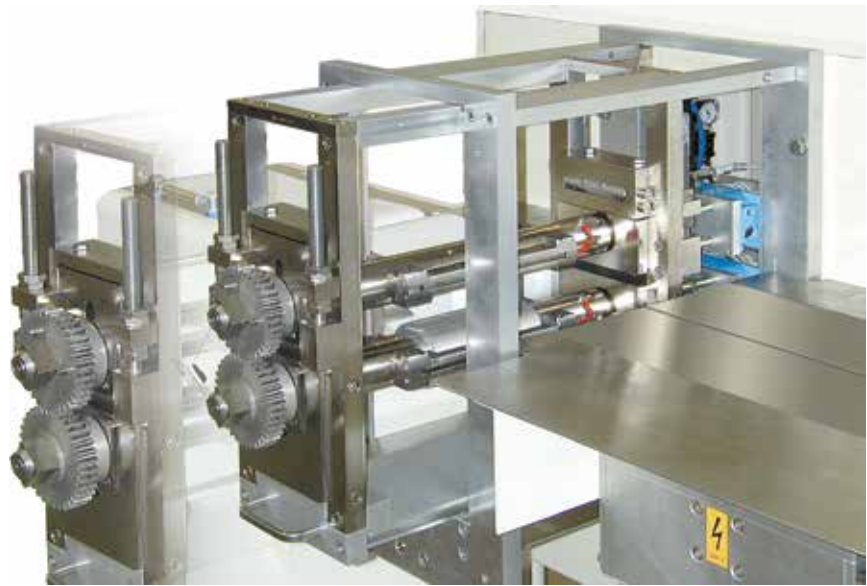

Quick changeover jaws-assembly

Data sheet

Weight	1.400 kg
Max. reel width	570 mm / 770 mm
Max. reel diameter.....	400 mm
Height of reel holder axis.....	1460+/-50 mm
Max. reel weight	40 kg
Height of infeed and outfeed conveyors	860+/-50 mm
Colour.....	STEEL-IT
Max. power supply.....	6 kVA

Line dimensions (mm)

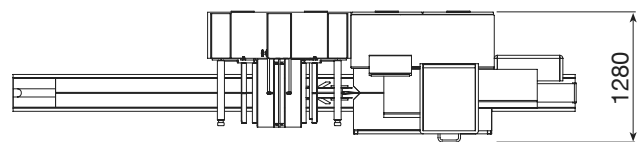
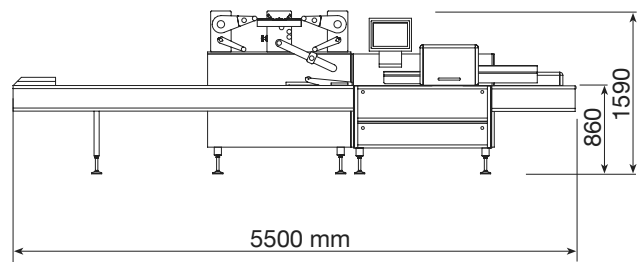

Minimum and maximum product dimensions*

- Length: 20 ÷ 600 mm
- Width: 20 ÷ 400 mm
- Height: 5 ÷ 100 mm

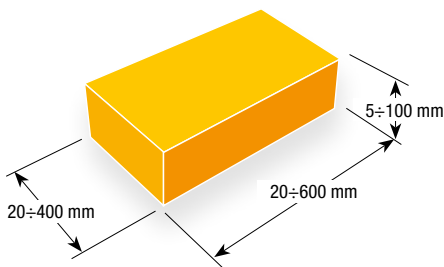

* Minimum and maximum dimensions do not coexist.
The above-mentioned data aren't binding. We have the right to change the specifications of the products without notice.

Zero 5 Box Motion wrapper

Electronic wrapping machine with semi-automatic or automatic feeding for hermetically tight packages



Products to treat

Cakes. Cheese. Frozen food.
Pharmaceutical products.

Type of machine

Continuous motion horizontal packaging machine for wrapping products by using thermo-sealable materials taken from reel. Transversal sealing with “box motion” system. Designed to meet the growing demand for quick changeovers, it combines easy use and maintenance, low-cost operation and high performance.

Speed

Up to 200 paks per minute depending on the characteristics of the product to be wrapped and of the wrapping material being utilized.
(Wrapping material linear speed up to ~50 m/min).

Main features

- Sturdy construction, with painted steel plates
- Monitor and keyboard easily accessible for quick data entry and prompt reading of packaging machine working conditions
- Password protection to prevent tampering by unauthorized personnel
- Diagnostics with help messages and troubleshooting
- Several languages are available for video-messages
- Graphic interface for easy learning and operation of the machine
- Graphic instructions to operator for changeover and manual adjustment of size parts
- Rockwell ControlLogix® or ELAU® control electronics.



Zero 5 Box Motion wrapper

Reel-Holder

- Double reel-holder with oscillating braking system
- Option: automatic reel splicing without wrapper stop
- Max reel diameter: 400 mm
- Max reel-web: 570 mm
- Special version with reel-web up to 770 mm
- Height of reel-holder axis from floor: 1460 +/- 50 mm

Wrapping material print registration

- Fully automatic control by means of micro-processors, with 180° forward and backward automatic research
- Timing cam device to provide synchronous signals to fit other devices such as Coders, Labelling Machines, etc...



Box Motion transversal sealing device

Equipment

- Electronic servomotor drive system to control infeed chain, longitudinal sealing wheels and transversal sealing and cutting unit
- 3 independent longitudinal sealing groups with driven flap folding unit
- Special transversal sealing units, for high tightness levels

Wrapping material

Heat or cold sealable material



Touch-screen operator panel

Available options

- Powered unwinding roller
- Accompanying gusseting devices according to pack requirements
- Device to check empty, twin, not-registered packs and packs from reel splicer
- No-product no-bag function
- Cutless function (no-gap no-seal)
- Device to apply longitudinal or transversal tear tape
- Device to feed cardboard, taken from reel or magazine.
- Gas flushing device
- Longitudinal ultrasonic sealing



Forming box and longitudinal sealing

Data sheet

Weight	2.660 kg
Max. reel width	570 mm / 770 mm
Max. reel diameter.....	400 mm
Height of reel holder axis.....	1460+/-50 mm
Max. reel weight	40 kg
Height of infeed and outfeed conveyors	860+/-50 mm
Colour.....	STEEL-IT
Max. power supply.....	6 kVA

Line dimensions (mm)

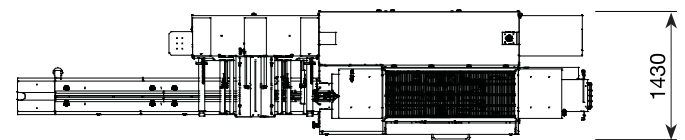
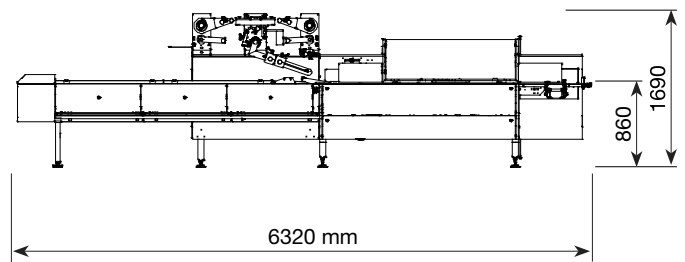

Minimum and maximum product dimensions*

- Length: 20 ÷ 1000 mm
- Width: 20 ÷ 340 mm
- Height: 5 ÷ 125 mm

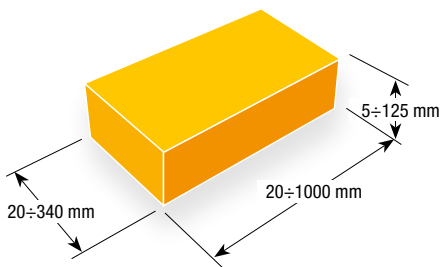

* Minimum and maximum dimensions do not coexist.
The above-mentioned data aren't binding. We have the right to change the specifications of the products without notice.

Zero 5 BRL wrapper

Electronic horizontal wrapper for high speed applications for products in tray



Type of machinery

Continuous motion horizontal packaging machine, designed for wrapping products in tray

Speed

Up to 200 ppm.

Wrapping material

Heat sealable or cold sealable material.



Data sheet

Colour:Steel-it grey
 Height from ground:850 ±50 mm
 Height from ground reel-holder spindles:1485 mm
 Height from ground of any CAB table:1210 mm
 Length (excluding infeed):3.000 mm
 Width:1.150 mm
 Height:1.600 mm
 Reel width:570 mm / 770 mm
 Max reel diameter:.....300 mm
 Max speed:200 ppm
 Film max speed:80 m/1'

Minimum and maximum product dimensions*

- Length: 100 ÷ 350 mm
- Width: 40 ÷ 200 mm
- Height: 20 ÷ 70 mm

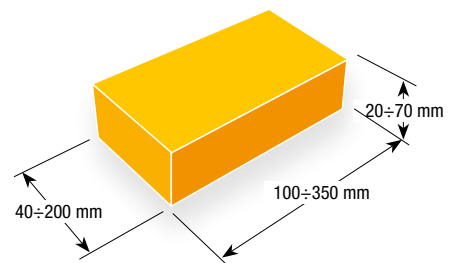

* Minimum and maximum dimensions do not coexist.
 The above-mentioned data aren't binding. We have the right to change the specifications of the products without notice.

Zero 5 NKZ wrapper

Electronic wrapping machine for slug products with automatic or manual feed



Type of machine

Horizontal continuous-motion wrapping machine for slug products. Conceived to appropriately meet the growing needs of fast format changes, it associates easy use and maintenance, low-cost operation and high performances.

Speed

Up to 100 packs per minute with standard transferring group
Up to 200 packs per minute with "accompanying" transferring group.

Main features

- Modular construction allowing high level of automation
- Tight control of the slugs at every stage of the operation
- Special devices adaptable for various product shapes
- Low maintenance level
- Reduced number of parts to be kept in stock
- Standardization of electric, electronic and mechanical parts
- Easy and fast changeover

- Friendly operating coloured touch-screen panel
- 99 sizes memory
- Gusseting device
- Rockwell ControlLogix® or ELAU® control electronics.

Wrapping material

Heat sealable or cold sealable material



Zero 5 NKZ wrapper



Two-way loading flight bar chain



High-speed rotating transfer unit



Transversal sealing and lateral fingers circuit

Available options

- Integrated vacuum system for air evacuation from the pack
- Modem card for remote assistance
- “Accompanying” transferring group
- High-speed rotating transfer unit (up to 250 ppm)
- Two-way loading pallet

Data sheet

Weight	kg 2400
Max. reel width	370 mm*
Max. reel diameter.....	400 mm
Height of reel holder axis.....	mm 1460+/-50
Max. reel weight	kg 40
Height of infeed and outfeed conveyors	mm 860+/-50
Colour.....	STEEL-IT
Max. power supply.....	kVA 11

* Option: max. reel diameter 570 mm

Minimum and maximum product dimensions**

- Length: 80 ÷ 350 mm
- Width: 35 ÷ 100 mm
- Height: 35 ÷ 100 mm
- Diameter: 35 ÷ 70 mm

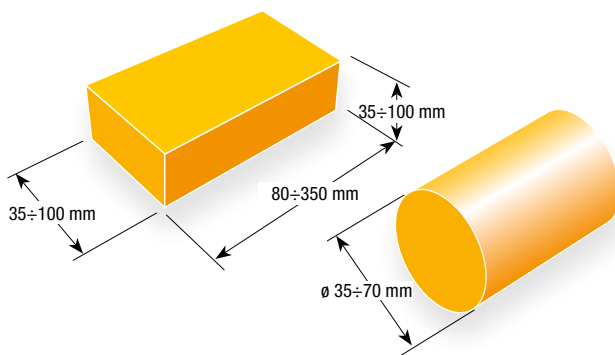
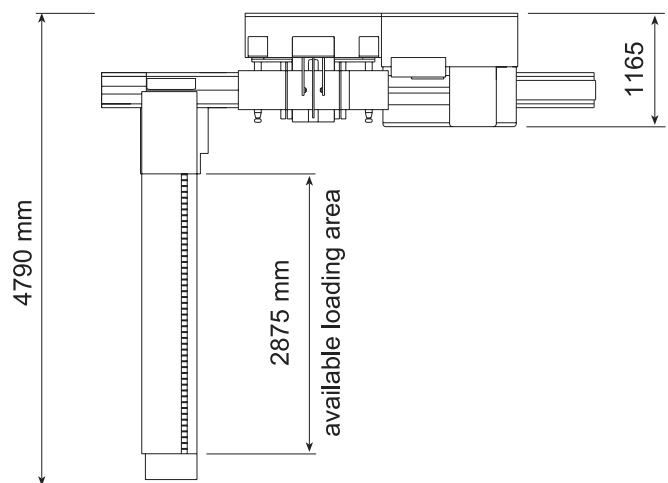
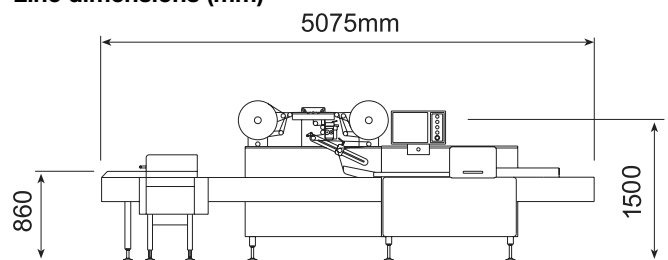
Line dimensions (mm)

** Minimum and maximum dimensions do not coexist.

The above-mentioned data aren't binding. We have the right to change the specifications of the products without notice.

Zero 5 R wrapper

Electronic wrapping machine with automatic infeed for special products



Suitable for

Products with irregular shape, weighty, and any other that cannot be wrapped by traditional wrapping machines.

Special applications for the pharma field.

Type of machine

Horizontal wrapping machine for pillow pack wrapped into material taken from reels placed beneath the infeed.

Speed

Over 300 packs per minute depending on the characteristics of the product to wrap and of the wrapping material. (Wrapping material linear speed up to approximately 80 meters per minute).

Main features

- Sturdy construction, with painted steel plates
- Monitor and keyboard easily accessible for quick data entry and prompt reading of the state of the wrapping machine
- Password protection to prevent tampering by unauthorized personnel
- Diagnostics with help messages and troubleshooting
- Several languages available for video-messages
- Graphic interface for easy learning and operation of the machine
- Graphic instructions to operator for changeover and manual adjustment of size parts
- Rockwell ControlLogix® or ELAU® control electronics



Zero 5 R wrapper

Infeed with aligning system (optional)

Detection and reject of faulty products (option)

Operator interface

Reel-Holder

- Double reel holder placed beneath the infeed, with pneumatic servo driven pressure locking device.
- Automatic reel splicing without wrapper stop (optional).
- Max. reel diameter: 400 mm.
- Max. reel-web: 570 mm.
- Special version with reel-web up to 770 mm.
- Reel-holder axis height from floor: 455 +/- 50 mm.

Wrapping material print registration

- Fully automatic control by means of micro-processors, with 180° forward and backward automatic research.
- Timing cam device to provide synchronous signals to fit other devices such as Coders, Labeling Machines, etc.

Equipment

- Electronic servomotor drive system to control infeed chain, longitudinal sealing wheels and transversal sealing and cutting unit.
- No. 3 independent longitudinal sealing groups with driven flap folding unit.
- Special long-dwell sealing units, for high tightness levels (long-dwell).

Wrapping material

Heat sealable or cold sealable material

Available options

- Transversal sealing unit installed on frame for quick removal in case of jaw change
- Powered unwinding roller
- Accompanying gusseting devices according to pack requirements
- Device to check empty, twin, not-registered packs and packs from reel splicer
- No-product no-bag function
- Cut-less function (no-gap no-seal).

Quick changeover jaws-assembly

Data sheet

Weight	1.400 kg
Max. reel width	570 mm
Max. reel diameter	400 mm
Reel holder axis height from floor	455+/-50 mm
Max. reel weight	40 kg
Infeed and outfeed conveyors height from floor	860+/-50 mm
Colour	STEEL-IT
Max. power supply	9 kVA

Minimum and maximum product dimensions*

- Length: 50 ÷ 600 mm
- Width: 30 ÷ 210 mm
- Height: 5 ÷ 140 mm

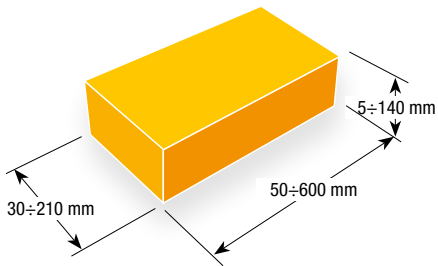
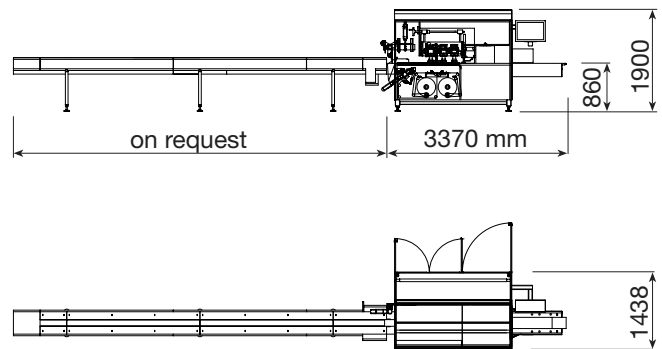
Line dimensions (mm)

* Minimum and maximum dimensions do not coexist.

The above-mentioned data aren't binding. We have the right to change the specifications of the products without notice.



Slim - Twin Slim wrapper

Electronic wrapping machine with semi-automatic or automatic feeding for high production speeds



Products to treat

Products with a fairly regular shape. Biscuits. Crackers. Bars. Chocolates. Pharmaceutical products. Non-food products.

Type of machine

Continuous motion horizontal packaging machine for wrapping products by using thermo-sealable and/or cold-sealable materials taken from reel.

The main feature of this packaging machine is to be very compact, it's in fact only 2 meters long and half a meter wide. Furthermore, you can combine two parallel machines (TWIN SLIM) with a single-sided operator at a distance of only 400 mm, with the same amount of space.

Great attention to the accessibility in both versions is one of the strong points of the machine.

It is easy to integrate with the "robotic" island as primary and secondary wrapping.

Speed

Over 1000 paks per minute depending on the characteristics of the product to be wrapped and of the wrapping material being utilized. (Wrapping material linear speed up to ~120 m/min).

Main features

- Sturdy construction, with painted steel plates
- Monitor and keyboard easily accessible for quick data entry and prompt reading of packaging machine working conditions
- Password protection to prevent tampering by unauthorized personnel
- Diagnostics with help messages and troubleshooting
- Several languages are available for video-messages
- Graphic interface for easy learning and operation of the machine
- Graphic instructions to operator for changeover and manual adjustment of size parts
- Rockwell ControlLogix® or ELAU® control electronics.

Slim wrapper



Reel-Holder

- Double reel-holder with oscillating braking system
- Option: automatic reel splicing without wrapper stop
- Max reel diameter: 400 mm
- Max reel-web: 370 mm
- Height of reel-holder axis from floor: 1550 +/- 50 mm

Wrapping material print registration

- Fully automatic control by means of micro-processors, with 180° forward and backward automatic research
- Timing cam device to provide synchronous signals to fit other devices such as Coders, Labelling Machines, etc...

Equipment

- Electronic servomotor drive system to control infeed chain, longitudinal sealing wheels and transversal sealing and cutting unit
- 3 independent longitudinal sealing groups with driven flap folding unit
- Transversal sealing unit installed on frame for quick removal in case of jaw change



Slim wrapper, side view.



Touch-screen operator panel



Quick changeover jaws-assembly

Wrapping material

Heat or cold sealable material

Twin Slim wrapper

Available options

- Powered unwinding roller
- Accompanying gusseting devices according to pack requirements
- Device to check empty, twin, not-registered packs and packs from reel splicer
- No-product no-bag function
- Cutless function (no-gap no-seal)
- Device to apply longitudinal or transversal tear tape
- Device to feed cardboard, taken from reel or magazine.



Line dimensions (mm)

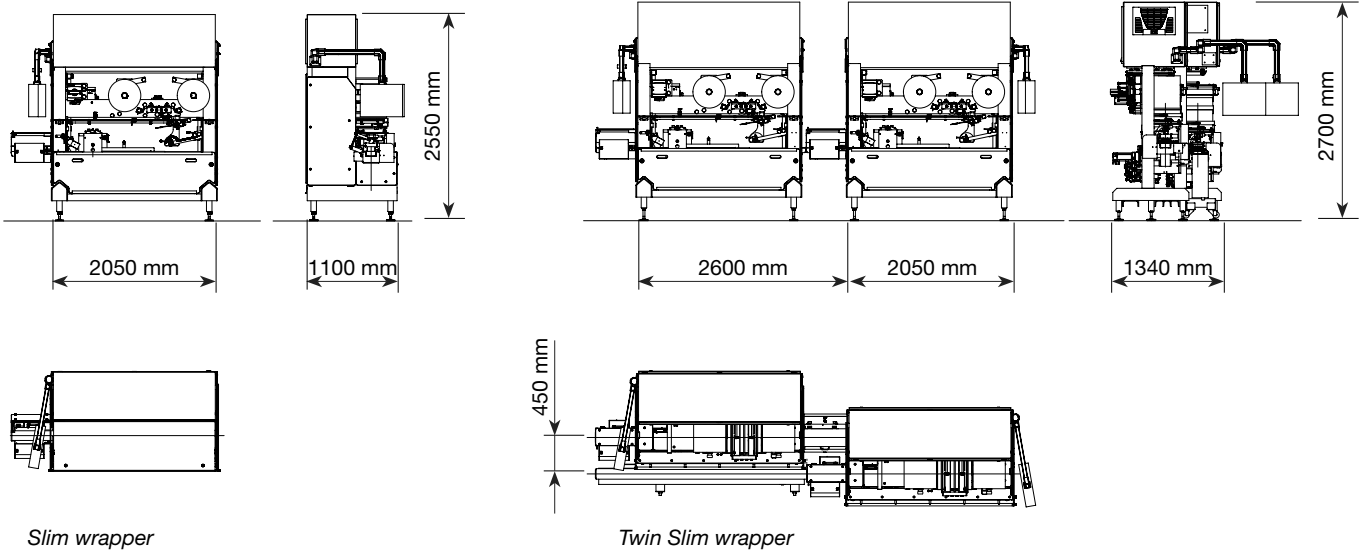

Data sheet

Weight	1.800 kg
Max. reel width	370 mm
Max. reel diameter	400 mm
Height of reel holder axis	1550+/-50 mm
Max. reel weight	40 kg
Height of infeed and outfeed conveyors	860+/-50 mm
Colour	STEEL-IT
Max. power supply	6 kVA

Minimum and maximum product dimensions*

- Length: 20 ÷ 600 mm
- Width: 20 ÷ 120 mm
- Height: 5 ÷ 50 mm

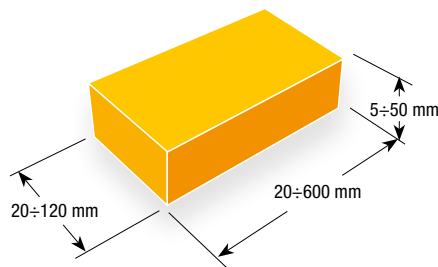

** Minimum and maximum dimensions do not coexist.
The above-mentioned data aren't binding. We have the right to change the specifications of the products without notice.*

Zero X

Electronic wrapping machine with semi-automatic or automatic feeding for high production speeds



Products to treat

Products with a fairly regular shape.
Biscuits. Crackers. Bars.
Non-food products.

Type of machine

Continuous motion horizontal packaging machine for wrapping products by using thermo-sealable and/or cold-sealable materials taken from reel. Designed to meet the growing demand for quick changeovers, it combines easy use and maintenance, low-cost operation and high performance.

Speed

UP to 1200 paks per minute depending on the characteristics of the product to be wrapped and of the wrapping material being utilized. (Wrapping material linear speed up to ~120 m/min).

Main features

- Sanitary Design Technology
- Sturdy construction, with painted steel plates
- Monitor and keyboard easily accessible for quick data entry and prompt reading of packaging machine working conditions

- Password protection to prevent tampering by unauthorized personnel
- Diagnostics with help messages and troubleshooting
- Several languages are available for video-messages
- Graphic interface for easy learning and operation of the machine
- Graphic instructions to operator for changeover and manual adjustment of size parts
- Rockwell ControlLogix® or ELAU® control electronics
- Reel holder assembly vertically movable to simplify reel holder change.



Zero X wrapper

Reel-Holder

- Double reel-holder with oscillating braking system
- Max reel diameter: 400 mm
- Reel-web: 370, 570 or 770 mm
- Height of reel-holder axis from floor: 1300 +/- 50 mm
- Driven unwinding roller

Wrapping material print registration

- Fully automatic control by means of micro-processors, with 180° forward and backward automatic research
- Timing cam device to provide synchronous signals to fit other devices such as Coders, Labelling Machines, etc...

Equipment

- Electronic servomotor drive system to control infeed chain, longitudinal sealing wheels and transversal sealing and cutting unit
- 3 independent longitudinal sealing groups with driven flap folding unit
- Special long-dwell sealing units, for high tightness levels
- Transversal sealing unit installed on frame for quick removal in case of jaw change

Wrapping material

Heat or cold sealable material

Available options

- Gusseting devices
- Cutless function (no-gap no-seal)
- No-product no-bag function
- Automatic crimper high adjustment
- Crimper twin motors
- Servo-driven inclination of the 1st pair of sealing wheels
- Air removal from the pack with vacuum pump
- Reel holder assembly vertically movable
- Control of simultaneous rotation of reels
- Automatic management of film tension
- Automatic film centering device
- Longitudinal or transversal tear tape.



Reel holder assembly vertically movable

Data sheet

Max. reel width	370, 570, 770 mm
Max. reel diameter	400 mm
Height of reel holder axis	1300 +/- 50 mm
Max. reel weight	40 kg
Height of infeed and outfeed conveyors	860 +/- 50 mm
Colour	STEEL-IT

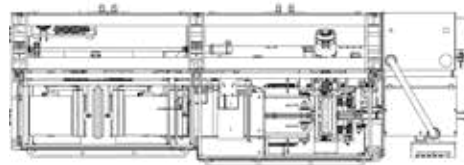
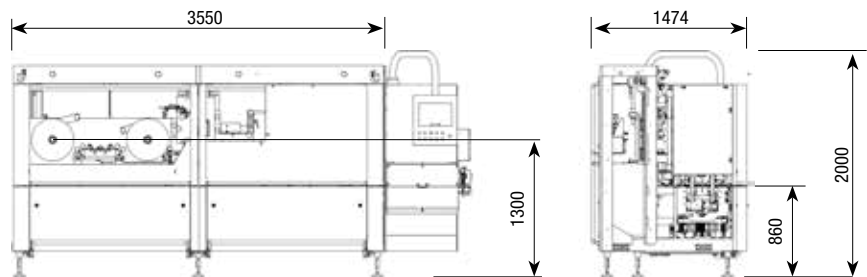
Line dimensions (mm)

Minimum and maximum product dimensions*

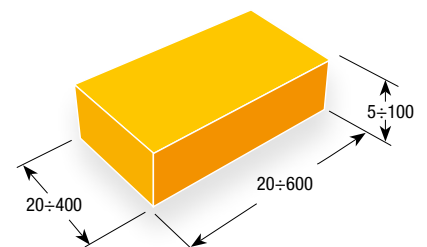
- Length: 20 ÷ 600 mm
- Width: 20 ÷ 400 mm
- Height: 5 ÷ 100 mm



* Minimum and maximum dimensions do not coexist. The above-mentioned data aren't binding. We have the right to change the specifications of the products without notice.

TND Loader

Loader for piles



TND Loader

Electronic loader made of one servodriven piston with vertical and horizontal movement. It transfers the products from the vertical magazine to the wrapper's chain.

Application

All kinds of common biscuits or wafers.
Feeding: Manual, automatic with belts, metal mesh conveyors, vibrators.

Peculiarity

It can form one or more piles.

Production

Up to 600 piles/min.

Size range*

- Length: 40 ÷ 100 mm
- Width: 40 ÷ 100 mm
- Height: 4 ÷ 10 mm
- Diameter: 40 ÷ 100 mm

Line dimensions (mm)

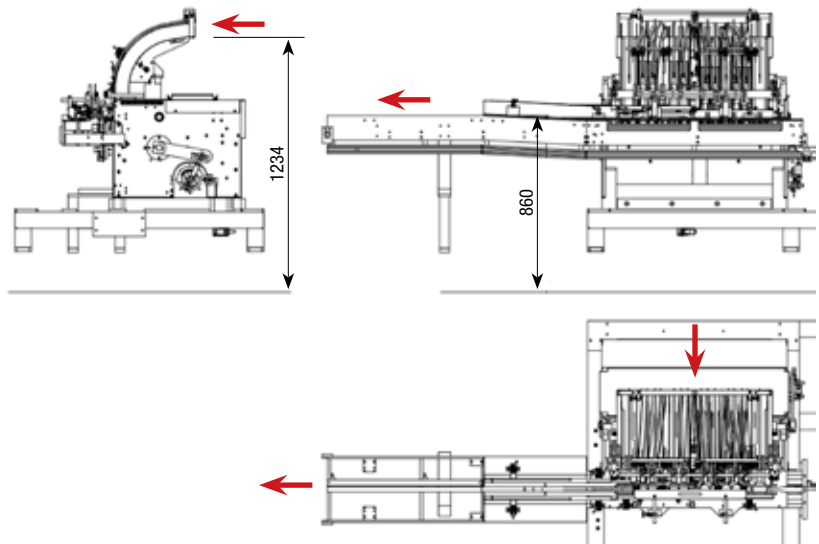

* Minimum and maximum dimensions do not coexist. The above-mentioned data aren't binding. We have the right to change the specifications of the products without notice.

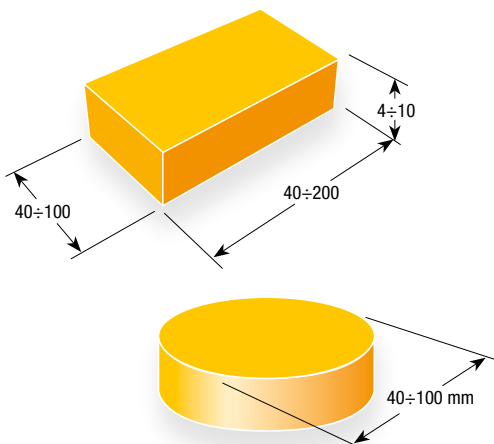

QF Loader

Loader for piles



QF Loader

Electronic loader forms piles of products first and then transfers the piles into the wrapper's infeed chain. This system transfers the products from the vertical magazine to the wrapper's infeed chain. It is possible to make any pack combination regardless of the number of magazines.

Application

All kinds of common biscuits.
Feeding: Manual, automatic with belts, metal mesh conveyors, vibrators.

Peculiarity

It can form one or more piles

Production

Up to 600 piles/min.

Size range*

- Length: 40 ÷ 90 mm
- Width: 40 ÷ 90 mm
- Height: 4 ÷ 10 mm
- Diameter: 40 ÷ 90 mm

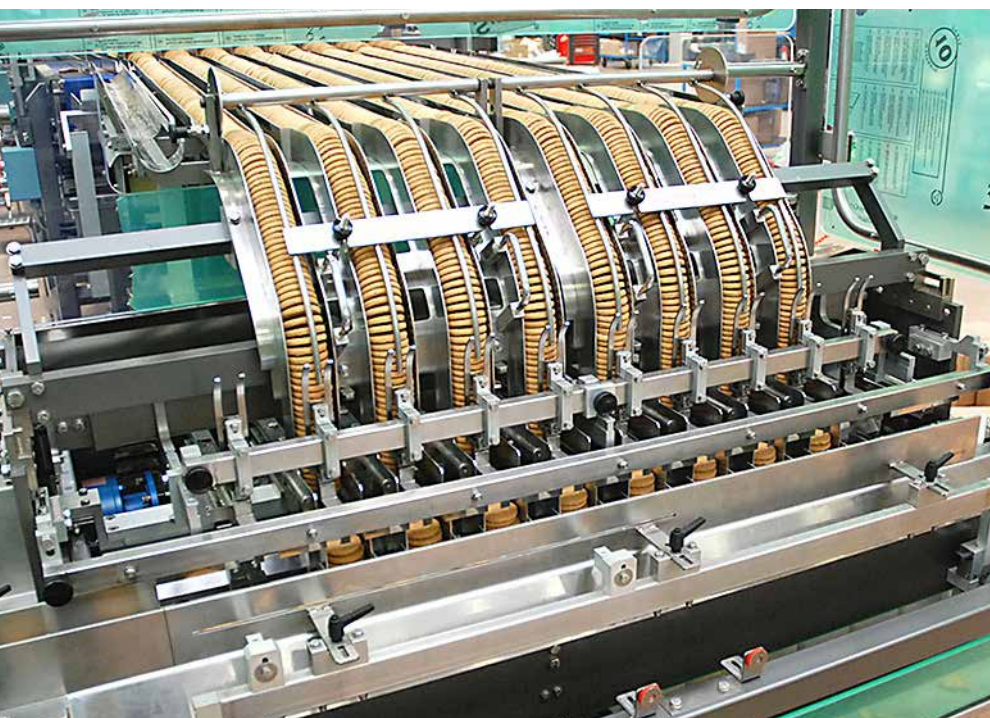
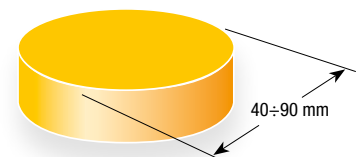
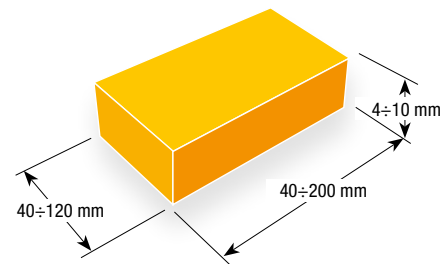

** Minimum and maximum dimensions do not coexist.
The above-mentioned data aren't binding. We have the right to change the specifications of the products without notice.*

ESP Loader

Loader for piles



ESP Loader

Electronic loader made of a series of magazines with an intelligent vertically adjustable base platform. The flight finger takes the products only from the desired magazines. This gives more flexibility to make any pack combinations. The movable base platforms are servodriven.

Application

All kinds of common biscuits.
Feeding: Manual, automatic with belts, metal mesh conveyors, vibrators.

Peculiarity

It can form one or more piles

Production

Up to 600 piles/min.

Size range*

- Length: 40 ÷ 200 mm
- Width: 40 ÷ 120 mm
- Height: 4 ÷ 10 mm

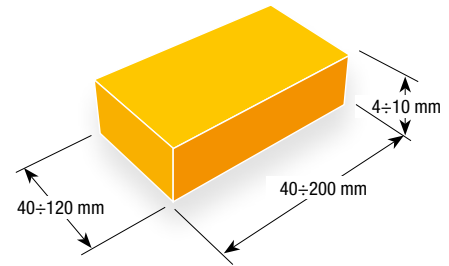

** Minimum and maximum dimensions do not coexist.
The above-mentioned data aren't binding. We have the right to change the specifications of the products without notice.*



SBF Loader

Volumetric loader for slugs fully electronic



SBF Loader

Electronic volumetric loader able to separate a portion of biscuits measuring its length, starting from the previous channeled lanes.

Application

All kinds of common biscuits
Feeding: Semi-automatic or automatic with metal mesh conveyors, belts, vibrators.

Peculiarity

Very practical entry height.
Fully programmable. Rockwell ControlLogix® or ELAU® control electronics





Production

Up to 35 cycles/min

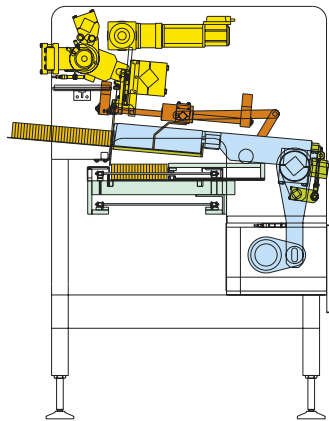
Maximum number of channels

Up to 14



-  Separator
-  Portioning group
-  Flip-flop moving group
-  Product discharge group
-  Product

Size range*

- Length: 40 ÷ 120 mm
- Width: 26 ÷ 80 mm
- Height: 35 ÷ 100 mm
- Diameter: 26 ÷ 80 mm

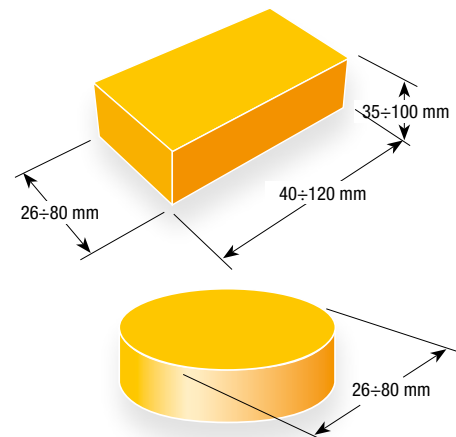

** Minimum and maximum dimensions do not coexist.
The above-mentioned data aren't binding. We have the right to change the specifications of the products without notice.*

MAF Loader

Numeric loader for slugs



MAF loader

Electronic numeric loader able to separate a portion of biscuits based on the desired number of product, starting from the previous channeled lanes.

Application

All kinds of special biscuits also very thick.
Special for sandwiches.

Feeding

Semi-automatic or automatic with metal mesh conveyors, belts, vibrators.

Peculiarity

Very practical entry height. Fully programmable.

Production

Up to 35 cycles/min

Maximum number of channels

1-14

Size range*

- Length: 40 ÷ 120 mm
- Width: 26 ÷ 80 mm
- Height: 35 ÷ 100 mm
- Diameter: 26 ÷ 80 mm

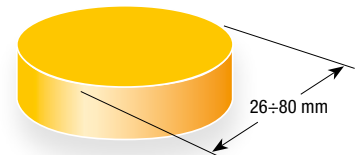
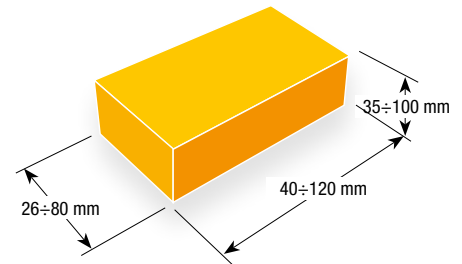

** Minimum and maximum dimensions do not coexist.
The above-mentioned data aren't binding. We have the right to change the specifications of the products without notice.*

TSL Loader

Numeric loader for biscuits on slug with or without tray



TLS loader

Electronic numeric loader able to separate a portion of biscuits based on the desired number of product, starting from the previous channeled lanes.

Application

Sandwich biscuits enrobed or not, biscuits enrobed or not and cookies.

Feeding

Semi-automatic or automatic with metal mesh conveyors, belts, vibrators.
Flat products arrival.

Peculiarity

Very practical entry height. Fully programmable.

Type of portion

Slug in one lane up to 300 mm
Slug in two lanes up to 145 mm

Production

Arrival lane number: from 4 to 16
Up to 65 biscuits/min for each lane (tray)
Up to 85 biscuits/min for each lane (slug)

Size range*

- Diameter: 35 ÷ 75 mm

** Minimum and maximum dimensions do not coexist.
The above-mentioned data aren't binding.
We have the right to change the specifications of the products without notice.*



Line dimensions (mm)

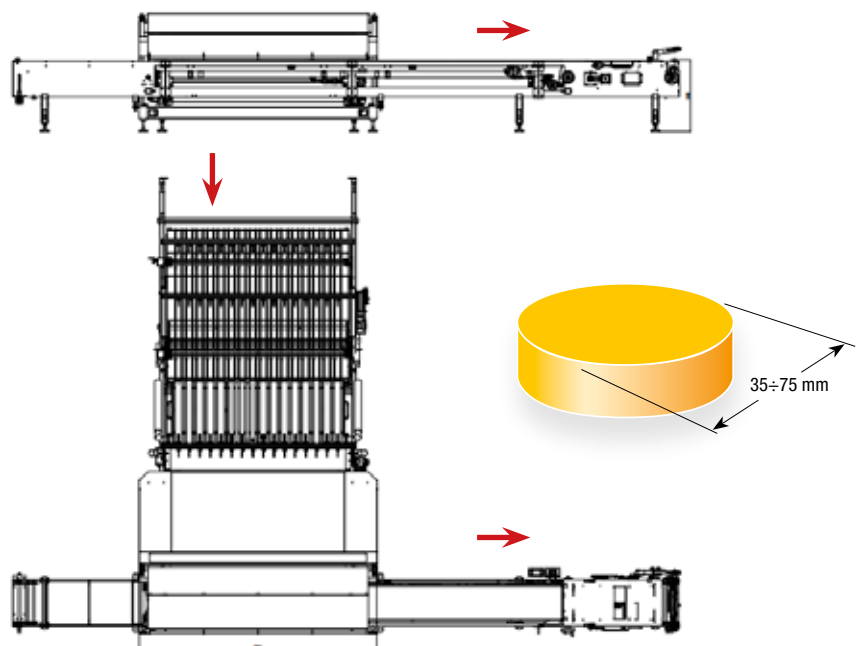

MDB Loader

Volumetric loader for slugs fully electronic



MDB Loader

Electronic volumetric loader able to separate a portion of products measuring its length, starting from the previous channeled lanes and then rotate it sidewise to allow proper wrapping.

Application

All kinds of common rusks.
Feeding: semi-automatic or automatic.

Peculiarity

Very practical entry height.
Reliable rusk handling (on mould sides). Fully programmable. Rockwell ControlLogix® or ELAU® control electronics.

Production

Up to 10 cycles/min.

Number of channels

According to application.

Motorizations

Portioning: 2 servomotors
Handling: 3 servomotors
Bar chain: 1 servomotor



Entrance into the loader (vibrating channels)



Slugs rotation

Size range

- Length: 70 ÷ 240 mm
- Width: 60 ÷ 75 mm (approximately)
- Height: 75 ÷ 130 mm

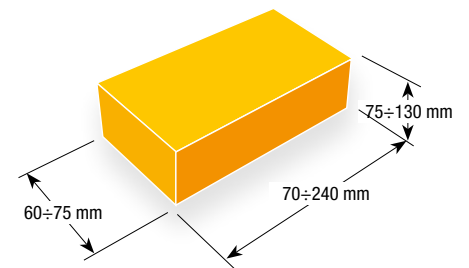

We have the right to change the specifications of the products without notice.



MDB Loader

Pi.Co. Loader

Numeric loader for biscuit in piles or slugs



Pi.Co. loader

Electronic numeric loader able to separate a portion of products in pile or slug with an easy changeover

Application

Sandwich biscuits, wire cut and round rotary molded

Feeding

Automatic with metal mesh conveyors, belts, vibrators.
Arrival lane number: 2

Peculiarity

Tool-free changeover and focus on ergonomics

Type of portion

Pile:

L1 H2 

L2 H2 

L3 H2 

L4 H2 

L1 H1 

L2 H1 

L3 H1 

L4 H1 

Slug: 

6÷12 pcs (80÷250 mm)

Production

Up to 1600 products/min (800 for each lane) if pile H2

Up to 1500 products/min (500 for each lane) if pile H1

Up to 1200 products/min (600 for each lane) if wire cut biscuits on pile

Up to 1200 products/min (600 for each lane) if wire cut biscuits on edge

Type of products

- Round
- Square

Size range

- Length: 40 ÷ 80 mm
- Width: 40 ÷ 80 mm
- Height: 6 ÷ 13 mm
- Diameter: 40 ÷ 80 mm

Line dimensions (mm)

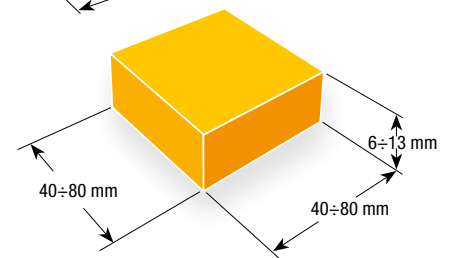
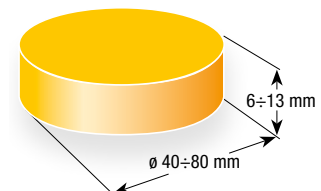
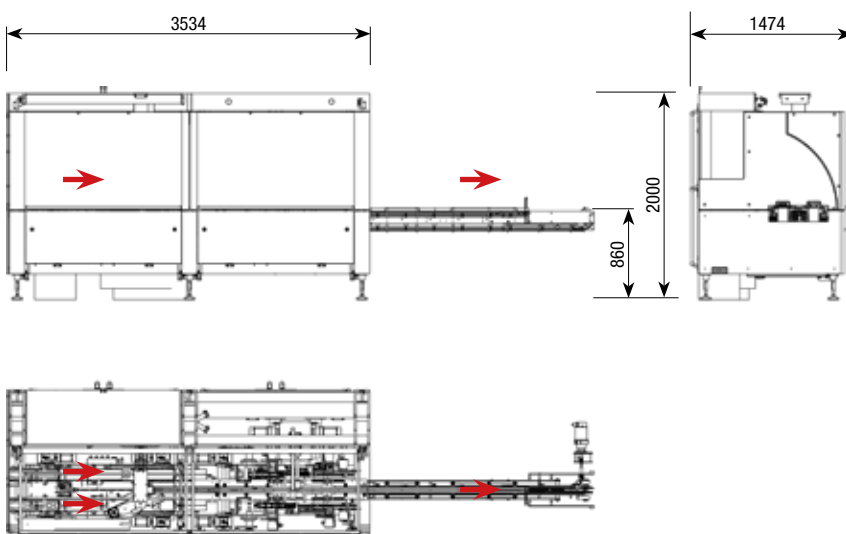

** Minimum and maximum dimensions do not coexist.
The above-mentioned data aren't binding. We have the right to change the specifications of the products without notice.*

90° transversal belts loader

Continuous motion belt loader



Application

Perfectly suitable for round products. Bars in general, wafers, products with a sufficiently regular shape, layer cakes.

Type of machine

Unique product infeed system by means of a series of servo-driven belt conveyors, placed at 90° of the wrapper's infeed chain.

The insertion of the single products between the flight fingers of the infeed chain is direct.

Speed

Up to 400 ppm

General characteristics

- Solid construction guaranteeing minimum maintenance operation

- Cantilevered construction
- Easy removal of conveyors for the cleaning
- Automatic centering of conveyor belts
- All belts are driven by alternating current brushless servomotors
- Wrapping machine integrated electronic control
- Workplace safety protections as legally required.
- Easy format changeover.
- Reduced space
- Reduced linear speed of the conveyor belts

Size range*

- Length: 40 ÷ 150 mm
- Width: 20 ÷ 50 mm
- Height: 10 ÷ 40 mm

Other sizes available upon request

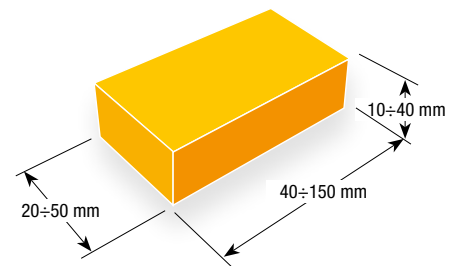

** Minimum and maximum dimensions do not coexist.
The above-mentioned data aren't binding. We have the right to change the specifications of the products without notice.*

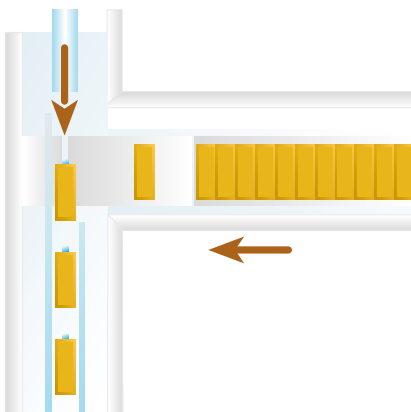

Operation layout



105°- 90° transversal belts loader

Continuous and or intermittent motion belt loader

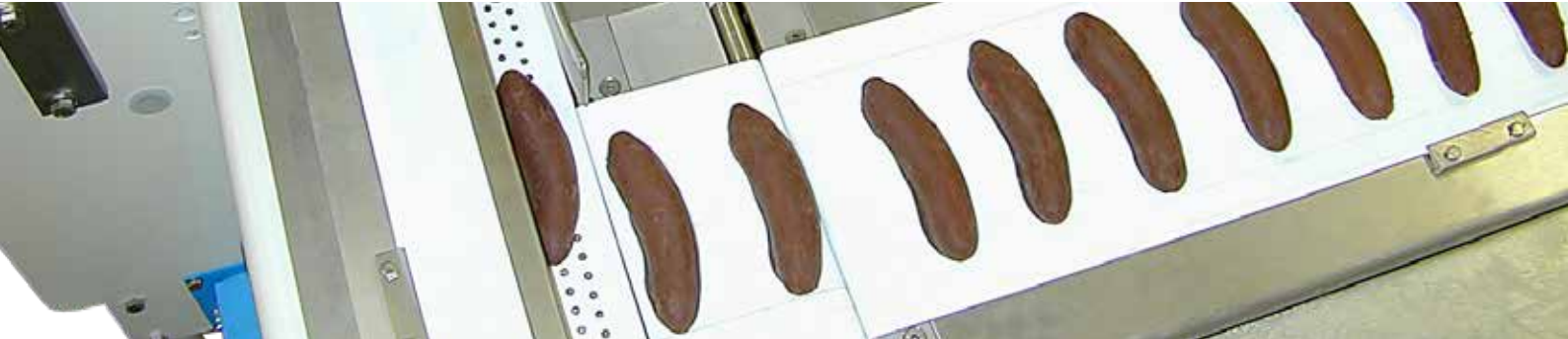

Application

- **105°:** perfectly suitable for rectangular bars since the open angle avoids the sliding between products when inserted into the infeed chain. Bars in general, wafers, products of a sufficiently regular shape.
- **90°:** perfectly suitable for round products. Bars in general, wafers, products with a sufficiently regular shape.

Type of machine

Continuous motion belt loader positioned at 105° (or 90°) with respect to the feeding chain of the wrapping machine.
The feeding of products, single ones, alongside, or overlapped, occurs through the lugs of wrapper infeed chain.

Speed

Up to 400 ppm

General characteristics

- Solid construction guaranteeing minimum maintenance operation
- Cantilevered construction
- Easy removal of conveyors for the cleaning
- Automatic centering of conveyor belts
- All belts are driven by alternating current brushless servomotors
- Wrapping machine integrated electronic control
- Workplace safety protections as legally required
- Easy format changeover.

Size range*

- Length: 40 ÷ 150 mm
 - Width: 20 ÷ 50 mm
 - Height: 10 ÷ 40 mm
- Other sizes available upon request

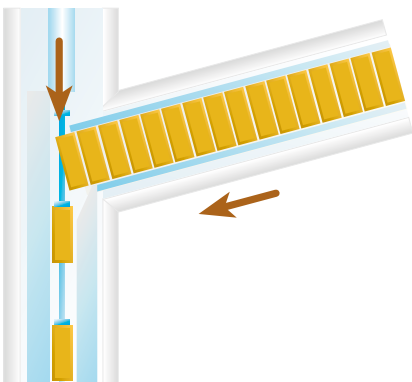
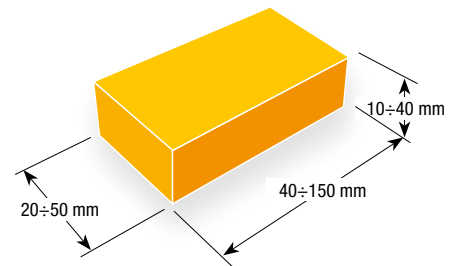

Operation layout 105°

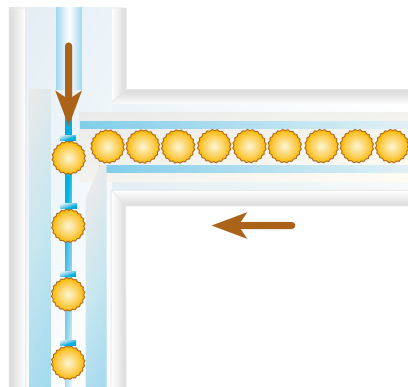

Operation layout 90°

** Minimum and maximum dimensions do not coexist.
The above-mentioned data aren't binding. We have the right to change the specifications of the products without notice.*

In-line “STREAM” belt feeder

Continuous motion belt loader



Suitable for:

Bars, chocolate bars, extruded products. Snacks either enrobed or not, cakes and sandwich biscuits, wafers, products with regular or irregular shape.

Type of machine:

Electronic horizontal feeder composed of a set of conveyor belts, each one with its own motorization and having the function to receive the products from the processing line and deliver them phased to the wrapping machine.

The cantilevered structure of the conveyor belts makes cleaning and maintenance easier, moreover it guarantees the absolute safety of operations.

The use of an advanced electronic technology allows to reach high performances.

Products can be fragile, dusty, sticky: they are all carefully managed.

If requested by features of the products, these can be conveyed without pressure or contact between them.

Working

The “Stream” feeder receives products in one lane discharged by an “SDR” station or by a buffer system type “FIFO”.

Products, if necessary, are longitudinally turned and aligned. According to the product features and to the final pack configuration, the feeder is properly designed to ameliorate the wrapping process.

The feeder can be composed of simple or controlled accumulation system, or structured so that the products do not collide.

The product insertion between the machine infeed chain lugs can be in-line or 105° angled.

General features

- Independent driven belts
- Cantilevered construction
- Product turning units
- Highly accessible and hygienic
- Modular construction
- Maximum flexibility
- Single-track or multi-track infeed
- Angle infeed
- Size format change through electronic program.

Size range*

- Length: 30 ÷ 100 mm
- Width: 30 ÷ 100 mm
- Height: 30 ÷ 100 mm

Other sizes available upon request

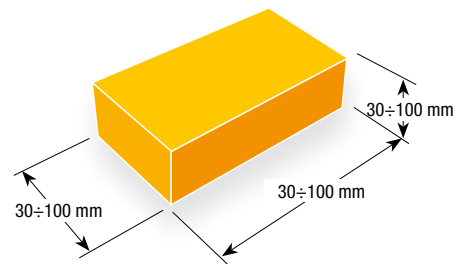
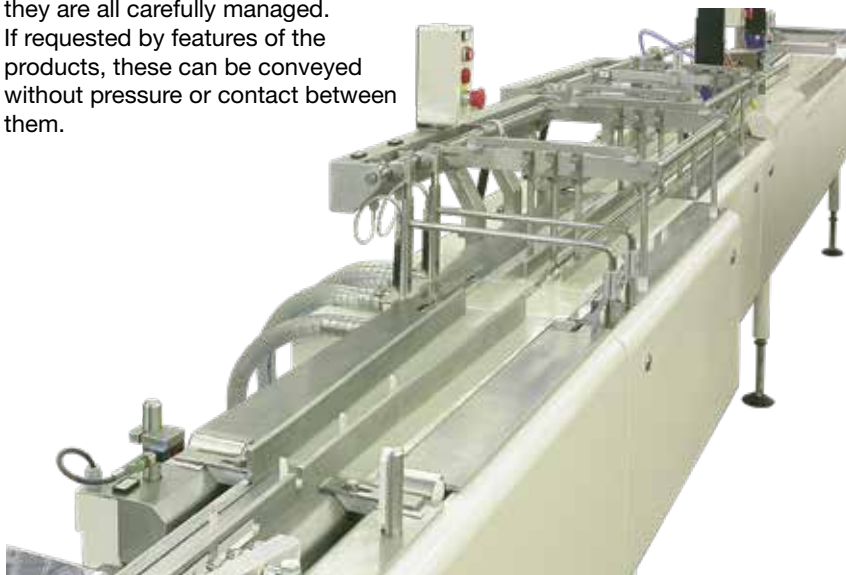

* Minimum and maximum dimensions do not coexist.
The above-mentioned data aren't binding. We have the right to change the specifications of the products without notice.

“CKDW” loader

Portioning loader device with continuous movement



Suitable for:

Mostly suitable for handling of “family packs” wafers.

Type of machine:

Fully servo-assisted
Easy changeover

Working

Unit to feed wafers by servo-assisted belts
Portioning/Slackening unit in line with the wrapper

Speed

Up to 170 cycles/min on one lane

Size range*

- Length: 80 ÷ 300 mm
 - Width: 30 ÷ 150 mm
 - Height: 10 ÷ 70 mm
- Other sizes available upon request

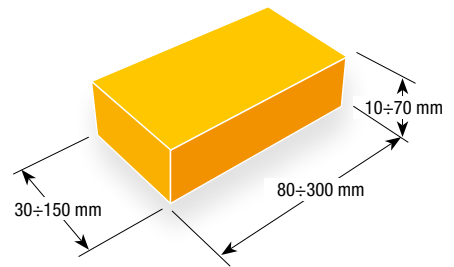

Portioning disk



Portioning disk for medium speed applications.
Up to 300 cycles/min



Portioning disk for high speed applications.
Up to 400 cycles/min



Two phases for portioning and putting into the wrapper infeed chain with lugs

Suitable for:

Small packs of wafers: one or two pieces one beside the other, either plain or covered with chocolate.

Working

Portioning disk, in-line with the wrapper.

Size range*

- Length: 50 ÷ 130 mm
- Width: 15 ÷ 40 mm
- Height: 10 ÷ 30 mm

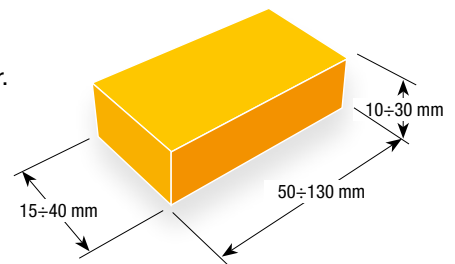

* Minimum and maximum dimensions do not coexist.
The above-mentioned data aren't binding. We have the right to change the specifications of the products without notice.

Row distribution System type “DR”

Automatic distribution system for products arriving in regular rows

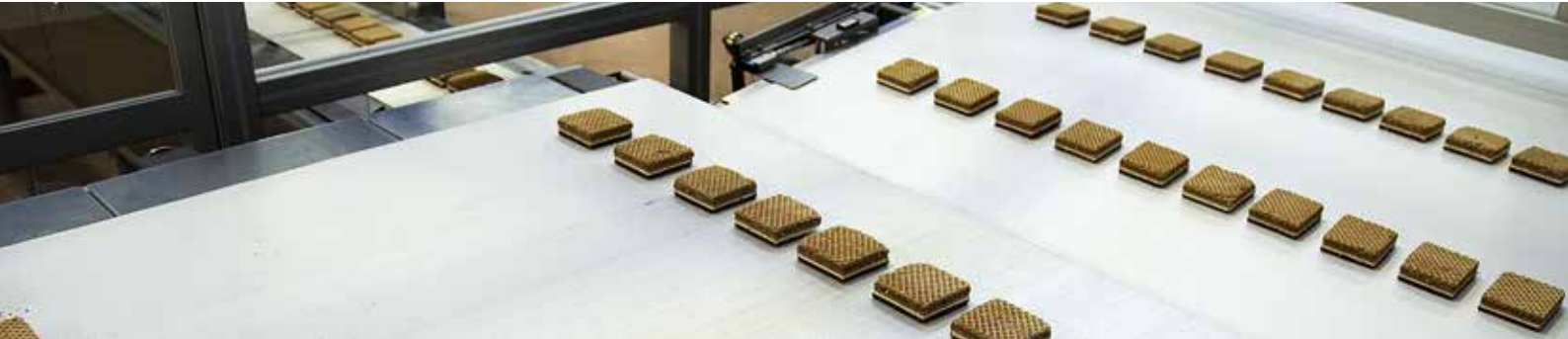

Suitable for:

- Chocolate bars
- Bars
- Extruded products
- Snacks either coated or not
- Cakes
- Sandwich biscuits.

Type of machine

DR is an automatic distribution system for round, square and rectangular products arriving in aligned and regular rows.

The system can feed one or more wrapping lines, be connected to a buffering system or to a product refeed station.

DR can be connected to the products cooling tunnel exit or directly to the process line.

General Features

- Solid construction providing performance by minimal maintenance
- Cantilevered construction
- Belts easy to remove for cleaning
- Automatic conveyor belts centering
- Rows distribution without mechanical devices
- Conveying system easy to check
- All belts are driven by brushless servomotors or alternated current
- Electronic control integrated in the wrapping machine
- Gentle and pressure free control of product flow and accumulation
- Safety guards according to legal standards.

Working

A DR station is composed of three belts.

The first belt, connected to product arrival, discharges the rows onto the lower belt by retractile motion.

The discharge occurs without neither products sliding nor using of any further mechanical devices.

Conveyor belt with

- 850 mm
- 1050 mm
- 1250 mm
- 1450 mm

Arriving rows maximum frequency

Up to 120 per minute



Fitting of a “DR” distribution system on the “STREAM” conveyor infeed chain

The above-mentioned data aren't binding. We have the right to change the specifications of the products without notice.

Row distribution System type “SDR”

Automatic distribution system for products arriving in regular rows



Suitable for

- Chocolate bars
- Bars
- Extruded products
- Snacks either coated or not
- Cakes
- Sandwich biscuits.

Type of machine

SDR is an automatic distribution system for round, square and rectangular products arriving in aligned and regular rows.

The system can feed one or more wrapping lines, be connected to a buffering system or to a product refeed station.

SDR can be connected to the products cooling tunnel exit or directly to the process line.

General Features

- Solid construction providing performance by minimal maintenance
- Cantilevered construction
- Belts easy to remove for cleaning
- Automatic conveyor belts centering
- Rows distribution without mechanical devices
- Conveying system easy to check
- All belts are driven by brushless servomotors or alternated current
- Electronic control integrated in the wrapping machine
- Gentle and pressure free control of product flow and accumulation
- Safety guards according to legal standards.

Working

A SDR station is composed of three belts.

The first belt, connected to product arrival, discharges the rows onto the lower belt by retractile motion.

The discharge occurs without neither products sliding nor using of any further mechanical devices.

Conveyor belt with

- 850 mm
- 1050 mm
- 1250 mm
- 1450 mm

Arriving rows maximum frequency

Up to 150 per minute

The receiving belt can keep in stand-by two or more rows to guarantee a constant product flow towards the wrapping unit.



Row distribution system SDR

The above-mentioned data aren't binding. We have the right to change the specifications of the products without notice.

“TPC” cardboard dispenser from reels

For grooved and flat cardboard



Suitable for

Used in the cases in which product protection is required or where a square-cut package is necessary.

Type of machine

The device feeds in automatic, directly from the reel, grooved and/or flat cardboard, to insert it as a support for the products, in the feeding chain of the wrapping machine.

Speed

Up to 450 cycles/min

General characteristics

- Possibility of folding the cardboard on 3 or 4 sides of the product
- Conveyor system of the cardboard with needle chain for large cardboard
- Single reel
- Double reel
- Double reel with automatic splicer
- Maximum flexibility
- Wrapping machine integrated electronic control.

Types of standard folding

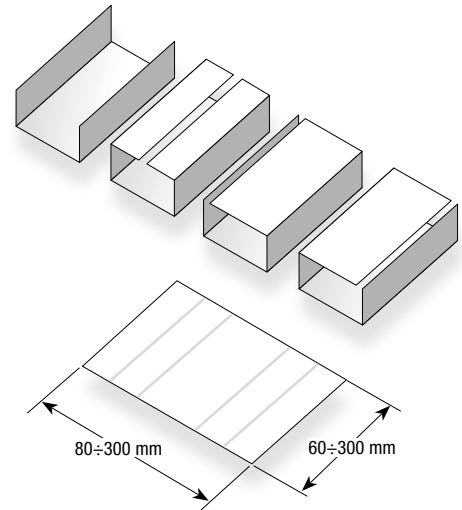

Cardboard size range*

- Length: 60 ÷ 300 mm
- Width: 80 ÷ 300 mm



The TPC device in the version with double reel support and automatic film splice system (CAB)



Cardboard grooving, cutting and folding

* Minimum and maximum dimensions do not coexist.
The above-mentioned data aren't binding. We have the right to change the specifications of the products without notice.

Flap folding device

Device for the heat folding down of the pack transversal sealing flaps



Suitable for

Particularly suitable for packs with square and rectangular products. Special version for packs with round products.

Type of machine

Unit placed at 90° to the wrapper exit, aimed to the heat sealing of the flowpack transversal sealing flaps till achieving the traditional square look.

Speed

Up to 300 ppm

General characteristics

- Positive packs conveying on the belt at 90° between wrapper and flap folding device.
- Modular structure of the heating system to fold the transversal sealing flaps.
- Independent heating of the sealing parts.
- Packs accompanied by Teflon lateral belts, which keep the packs separated from the heating plates.

Size range*

- Length: 100 ÷ 250 mm
- Width: 30 ÷ 150 mm
- Height: 30 ÷ 100 mm

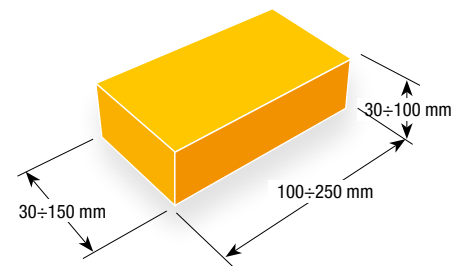

** Minimum and maximum dimensions do not coexist. The above-mentioned data aren't binding. We have the right to change the specifications of the products without notice.*

Vacuum Test System “VTS”

System to check the pack seals



VTS

The system has been studied and conceived to point out the features of the pack seals.

It is suitable for those production activities, which take care of rejects reduction, shelf life preservation and pack quality in general.

The test is very easy and consists in dipping the pack in the VTS tank. According to the Venturi system, a negative pressure is produced and such a pressure difference causes the pack expansion and swelling. The seals are then put under pressure and all possible leakages are noticeable in the form of water small bubbles.

Advantages

- Lowest time to point out any leakage
- Suitable for all kinds of pack
- Specialized personnel not required
- Easy erecting
- No maintenance
- No electrical connection required
- Supporting stool included
- Unloading plug



VTS 6



VTS 20

Technical specs

Model	VTS 6	VTS 20
External dimensions mm:	Ø 200 x h 350	450 x 300 x 300
Acrylic glass thickness mm:	20	25
Tank capacity lt:	6	20
Vacuum bar:	750	750
Vacuum production:	Venturi	Venturi
Compressed air input bar:	5-6	5-6

Dynamic buffer "FIFO" type

Dynamic vertical buffer with following movement of the gondola



Suitable for

Regular rows of snacks and chocolate bars single-portion. Trays. Boxes. Display boxes.

Description

The system consists of three units:

- Entry unit with products aligning group. It consists of a realignment system with rollers of incoming rows, with launching belt to allow the rows insertion on Gondolae with continuous movement. Cantilevered conveyors construction. Drive is by servo-motors
- Buffer. Modular frame sized in conformity with the available space and the required storage time. The standard model consists of a vertical conveyor with 4 storage coves
- Products discharge and exit group
 - In-line: it consists of a swinging conveyor belt and of a pusher inside the group feeding rows from shelves to belt

- 90°: one lane and dual lane, it consists of 1 or 2 transversal belts with intermittent motion, receiving rows from inner pusher and conveying them to one or more wrapping machines.

Both solutions foresee following movement Gondolae allowing a better motion fluency of Gondolae main chain reducing belt loading and lengthening

- Driven by two servo-motors
- Guarding with transparent Lexan
- Gondolae in polyamide with aluminium shelves
- Electromagnetic protection of entry doors

Underneath the frame, suitable extractable trays allow to collect any products or losses, in case. Control logic is Allen Bradley ControlLogix with Allen Bradley as operator interface.

A special electromechanical system linked up by electronic control allows automatic control and reset of Gondolae position giving an alarm when irregular lengthening of a belt compared to another occurs.

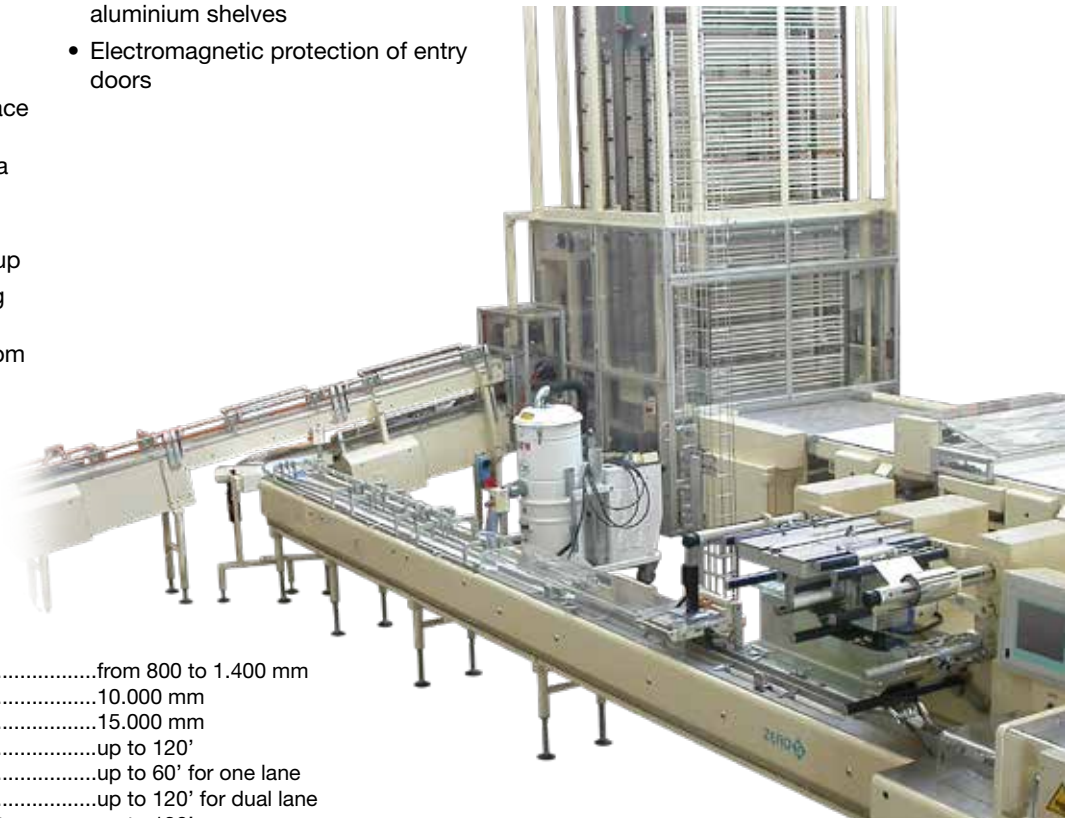

Technical data

Useful width:.....from 800 to 1.400 mm
 Maximum height:.....10.000 mm
 Maximum length:.....15.000 mm
 Maximum speed for incoming rowsup to 120'
 Maximum speed for rows on 90° exit:up to 60' for one lane
 Maximum speed for rows on 90° exit:up to 120' for dual lane
 Maximum speed for rows on in-line exit:up to 130'

Possibility to entry and exit on two different levels with elevator or descensional functions.

Multi-level horizontal buffer "LIFO" type

With SDR recycle station



Suitable for

Snack bars, chocolate bars, biscuits, or anyway products of a sufficiently regular shape laid out in rows.

Type of machine:

Distributing station up to four levels, with automatic research of the level of loading and unloading.

General characteristics

- Up to four buffer conveyors, step motion, with loading photocells.
- High speed rows alignment unit
- Recycle station SDR type
- Operator interface with loading level display

Technical data

Effective width:from 800 to 1.600 mm
 Maximum length for each level:12.000 mm
 Maximum speed infeed rows:up to 130'
 Maximum speed recycle:up to 50 rows per minute
 Possibility of application of conveyor washing stations.

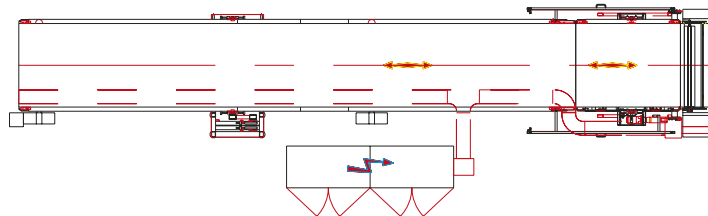
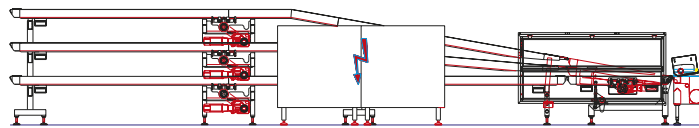

Multi-level buffer

DY-B Dynamic buffer

Dynamic buffer instead of standard accumulation buffer



Suitable for

Rusks, biscuits, crisp bread, crackers.

Type of machine

In order to offset possible machine stops, which can last several minutes, the Dynamic Buffer DY-B i.e. the buffer with mobile star-wheel stacker has been developed for the controlled accumulation of incoming products (rusks, biscuits, crisp bread, cracker). It is applied at the place of the standard accumulation buffer which is composed of variable speed conveyors positioned downstream of a star-wheel stacker system.

This system is a conveyor integrating a “floating shuttle with stacker” which is able to back off with increasing of incoming product quantity if the next machine is not running. The star-wheel stacker is positioned onto the floating shuttle.

Advantages

- Greater buffering capacity due to the unit of length
- Limited pressure among accumulated products (buffer speed does not change)

- Possibility to handle effectively products having difficulty in sliding among themselves (for ex. rusks) because products pass from flat position to the vertical one (max. stacking condition)
- Optimized stacking quality that is obtained by making independent the star-wheel movement. Each star-wheel is driven by a dedicated motor that starts when a photocell detects the product presence



DY-B Dynamic buffer

Notes on dynamic buffer operation

In normal conditions, that is when the downstream machine is operating normally, the shuttle or mobile stacking device is steady in a rest position.

When the downstream machine stops running for any reason the shuttle starts to work. It moves its position back adjusting its speed and it automatically makes space for new incoming products.

Its working principle is based on the fact that stacking is connected to the relative movement among each star wheel and the downstream machine. Timing and buffering capacities depend on length of conveyor integrating the mobile stacking unit, as well as product features and production speed.

Technical data

Products by rowup to 400 pieces per minute

Options available

Stacking wheels servo-driven and independent

Size product range*:

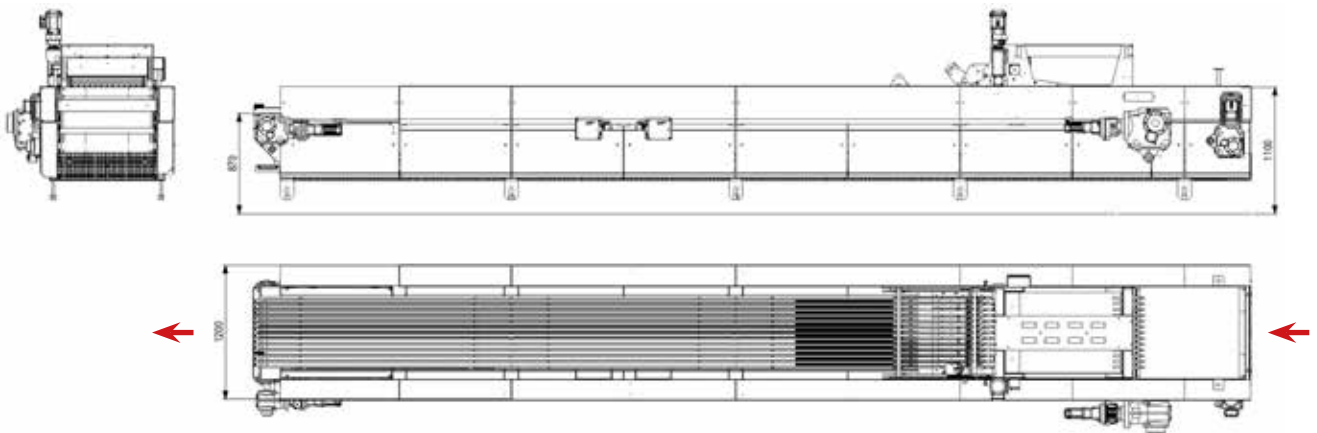
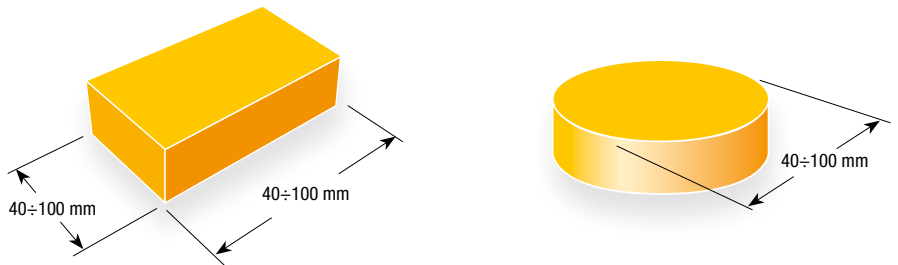

* Minimum and maximum dimensions do not coexist.
The above-mentioned data aren't binding. We have the right to change the specifications of the products without notice.

Robotic Multipack System G41



Cavanna proposal about cartooning for the medium and high speed segment

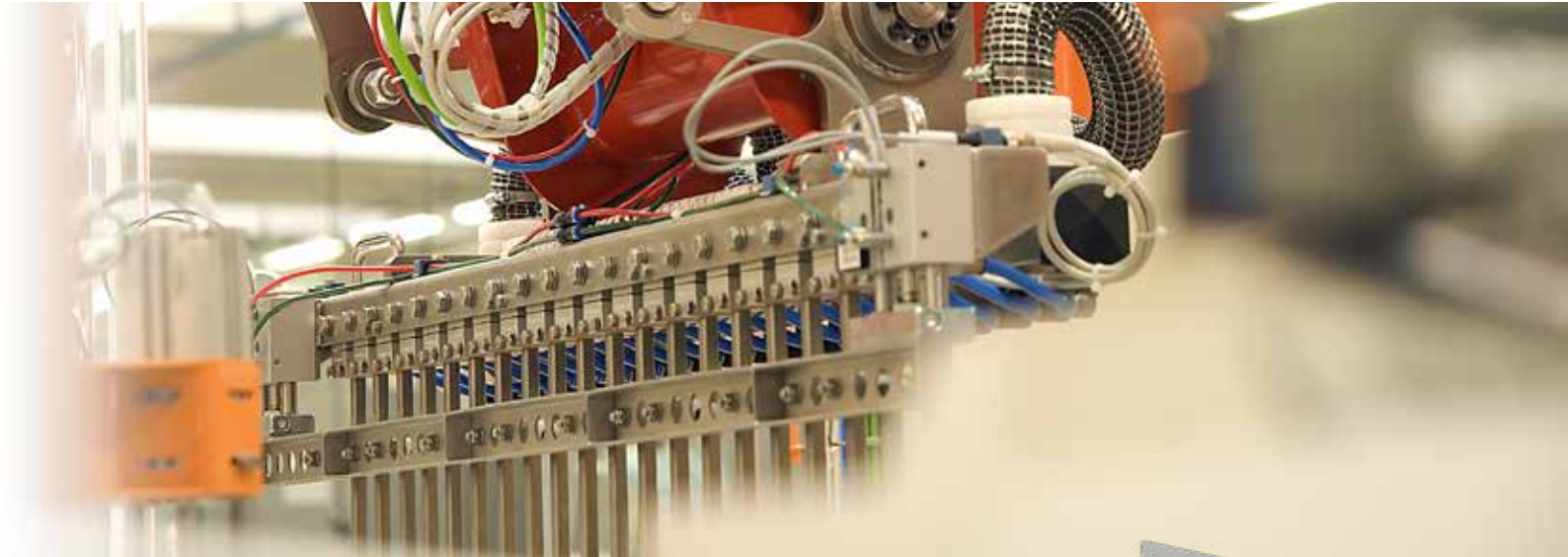

Products to treat:

All kinds of products to fill displays or American boxes,
In the CARTESIO robotics division Cavanna creates with the G41 model the compact solution for the “end line”. The box filling is carried out by a head sampling the products from the vertical arrangement device (VMC) with continuous feed from the packaging machine. Maximum inlet speed of VMC up to 600 pieces/minute. Electronic control system Schneider Electric or Allen Bradley.

Advantages

- Space reduction: the extremely compact structure, which makes G41 easy to insert in any kind of wrapping line
- Integration with the electronic control of horizontal wrapping lines and downstream systems
- Integration of complete supply: a single manufacturer able to know all details and needs of the flowpack and robotic world
- Great flexibility: it fits any customer need, also in the presence of forming or closing systems already present
- Fast format changes: the picking head is not so heavy, which makes format changes easy
- Electrical cabinet integrated into the robotic island



G41 F: fills

G41 FC: fills and closes

G41 EF: forms and fills

G41 EFC: forms, fills, closes

Some examples of cartooning

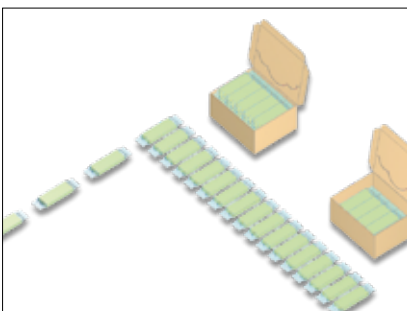

Display box filling with flat products

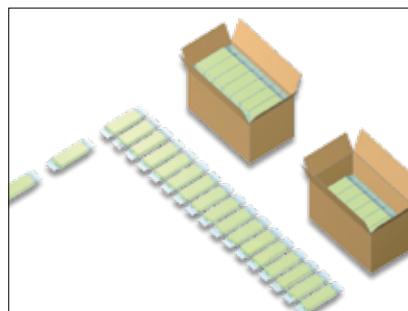

American box filling with flat products

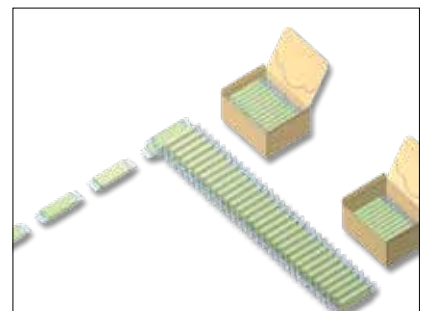

Display box filling with products on edge

G41 EFC



The most compact and complete solution: it forms the case, then fills and closes it



General features

The functions are reduced to the minimum: the case is formed with just one multiple sampling with suction cups, directly delivered on the conveyor that will take it to filling and closing.

The filling is carried out by a head sampling the products from the vertical arrangement device (VMC) with continuous feed from the packaging machine.

The closing is made by a multiple head that closes the cover and the lateral flaps with glue.

The technical solution of vertical arrangement device can be done with step-by-step motion or continuous motion.

With the first solution, it is possible to connect G41 with packaging machines: maximum inlet speed of VMC up to 600 ppm.

In the second solution, the continuous motion (VMC) coupled

with the oscillating insertion device (Cavanna patent), makes possible to connect G41 with high-speed packaging machines: maximum inlet speed of VMC up to 700 ppm.

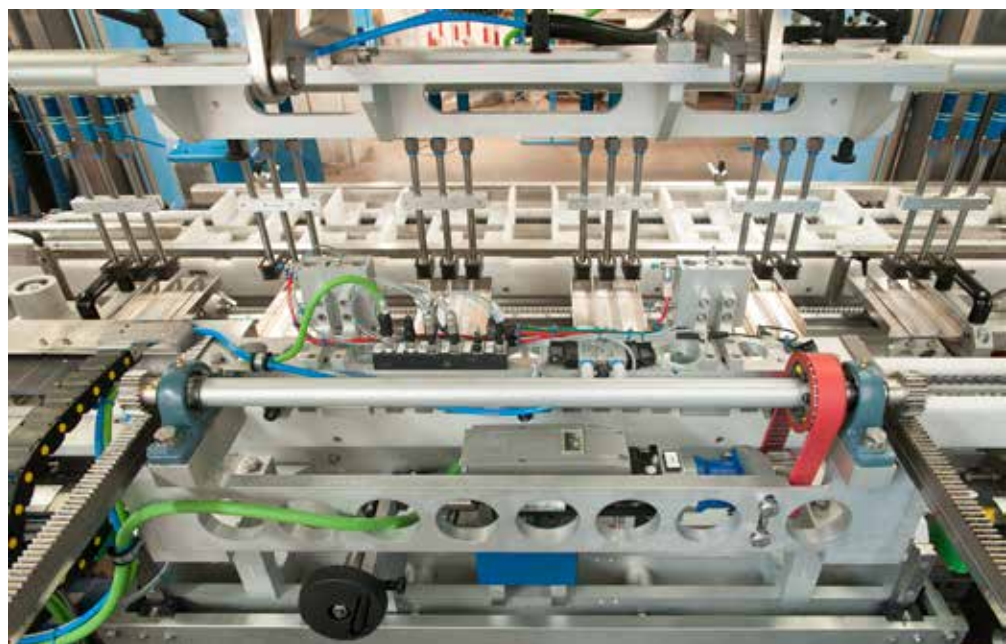

Advantages

- Space reduction
- Reduction of transfers of cases: cases are inserted directly - during the forming phase - in the chain conveyor and from the latter, without ever leaving them or transferring them to another system, they are taken to their closing and ejection. All the steps of empty cases or not yet closed that create obstructions in the operation are removed
- Integration between high-speed horizontal packaging machines and downstream machines with systems that speak the same language: just one electronic control that guarantees the perfect synchrony of motions
- Integration of complete supply: a single manufacturer able to know all details and needs of the flowpack world and of robotics
- Reliable operation: Having reduced the number of transfers of cases and the number of forming and closing manoeuvres, the machine has much lower possibilities of stops and failures
- Fast format changes: the format change was designed to replace altogether parts that keep the same adjustment, without requiring a fine-tuning time after they are put back in operation
- Interchangeable sampling heads and die-cuts warehouse



Technical Specifications

Tension:400 V/50Hz, 3 Phases
 Compressed-air:.....6bar
 Protection rating:.....IP54
 Touch-screen type
 (Touch-Screen)Magelis XBT GTW652 (12”) – Elau
 PanelView Plus 6 (10”) – Allen Bradley



Size product range*

- Length: 40 ÷ 250 mm
- Width: 10 ÷ 200 mm
- Height: 10 ÷ 100 mm

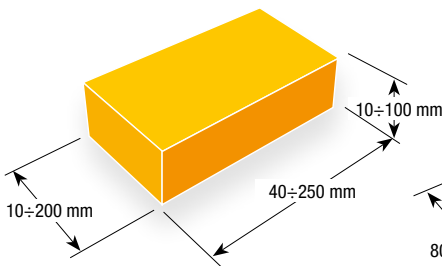

Size box range*

- Length: 100 ÷ 400 mm
- Width: 80 ÷ 250 mm
- Height: 30 ÷ 180 mm

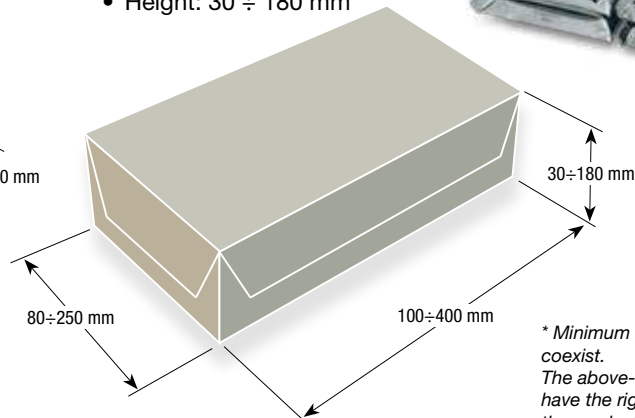

** Minimum and maximum dimensions do not coexist. The above-mentioned data aren't binding. We have the right to change the specifications of the products without notice.*

Robotic System P4



The P4 is a high-speed robotic pick and place system



It is a compact fast solution to automatically loading either flow wrappers or trays. The P4 robots are suitable to manipulate products continuously by means of a belt tracking system able to work directly in continuous or intermittent motion of the belts.

General features

A unique frame that includes two feeding belts: the first belt transfers and the second belt launches the products. The P4 can have one or two one-driven loading chains (VMC MonoTrack). The groups of products are picked by the robots and dropped into the wrapper's infeed chain. It is also possible to load plastic or paperboard trays coming from either a tray denester or a tray former.

Advantages

- Reduced floor space
- Robot high operating speed, up to 80 cycles/min
- Incoming speed of the products up to 450 PPM each lane
- One person, easy change-overs of the robot tools with quick connection systems for both electric power and compressed air supply
- Easy set-up of the robot work parameters by means of self-learning position
- User friendly touchscreen and multilingual operator interface (HMI) with integrated diagnostic
- Possibility to load any brand of wrapper
- Automatic operation of the cardboard coming from upstream by means of a No Cardboard No Place feature to avoid out of specs packs
- Complete integration of Cavanna wrappers
- Electrical cabinet included in the robotic cell. No extra space is required for the electrical components



Cavanna vision guided robotic systems



Cavanna proposal about vision guided robotic systems applied to packaging



These patent-pending systems represents an innovative concept in terms of layout and logic for what concerns the vision guided robotics applied to packaging. Compared to traditional systems, Cavanna can offer a more rational solution, able to cover even the widest conveyor belts, optimizing the operator layout and ergonomics. The Ring workcell (in particular) has been studied and developed together with our customers, in order to offer a machine with an increased sanitation, together with an easier changeover and an almost frictionless product transportation.

Advantages

- Vision HW fully embedded in the robot controller (no external PC necessary)
- Connection of up to 8 cameras
- Easy setup and maintenance

Ratings

- 2D matrix camera 640x480
- Typical product dimensions (mm) from 20x20 to 100x100 (h 10 to 40)*



Ring-6

Typical robotic system layouts and speed

Name	Typical product conveyor width	Number of robots	Typical product speed *	Output type *	Multipick Avail.	Typical products
Ring-6	1600-1700 mm	6	400-500 ppm	Piles of cookies (typ 1 to 4 high) Side-to side packages	No	Biscuits
Ring-4	1400-1600 mm	4	270-380 ppm	Piles of cookies (typ 1 to 4 high) Side-to side packages	No	Biscuits
U-4	1000-1400 mm	4	270-480 ppm	Piles of cookies (typ1 to 4 high) Side-to side packages Acetate trays ** Overwrappable trays **	Yes	Biscuits Confectionery Small bars
U-3	1000-1400 mm	3	200-360 ppm	Piles of cookies (typ1 to 4 high) Side-to side packages Acetate trays ** Overwrappable trays **	Yes	Biscuits Confectionery Small bars
U-2	800-1400 mm	2	130-240 ppm	Piles of cookies (typ1 to 4 high) Side-to side packages Acetate trays ** Overwrappable trays ** 3 flap boxes **	Yes	Biscuits Confectionery Small bars Bigger bars and tablets

* indicative data, to be validated by Cavanna engineering

** speed and dimensions to be validated by Cavanna engineering

Workcell advantages

- One single flowrapper even on a wide conveyor can be served by up to 6 robots
- Almost frictionless product transportation (Ring solution)
- Almost no mechanical interference of the robots
- Good use of the working envelope
- All the flowrappers can be positioned on the same side of the line
- Easy and clean changeover, especially on the Ring solution
- More stable behavior in case of product fluctuation

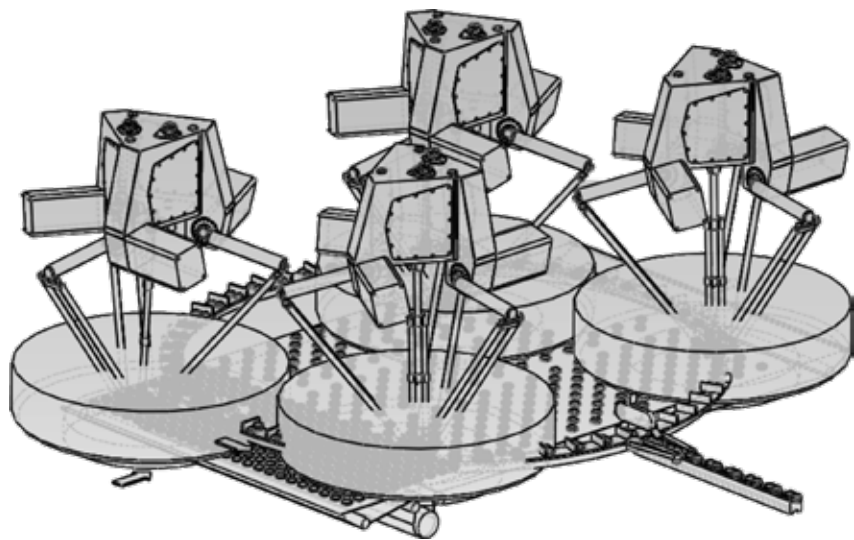

Ring-4

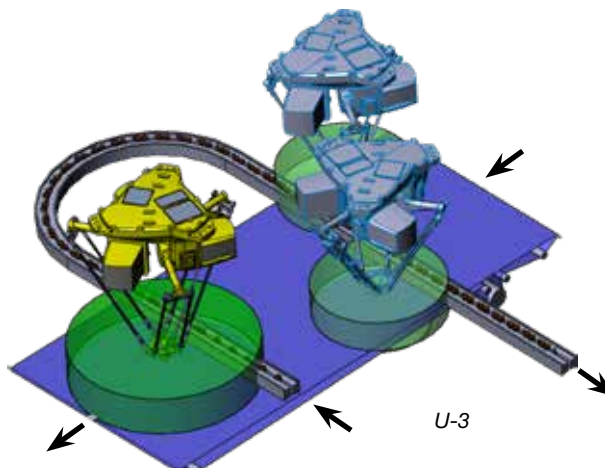

U-3

Carteasy

Cartooning packer unit



Suitable for

All kind of flowpack. Wafers, Trays, Sandwiches.

The packs out of the wrapper are transported on a conveyor belt up to the unit where the portion is formed, picked and put inside an American carton box.

Type of portion

Single products, side-by-side or on pile

Size product range*

- Length: 130 ÷ 260 mm
- Width: 40 ÷ 200 mm
- Height: 15 ÷ 60 mm

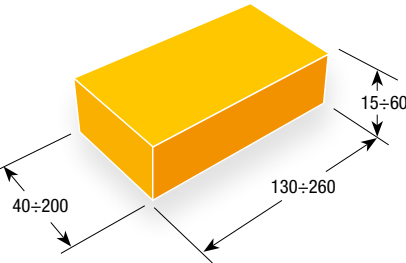

Size box range*

- Length: 160 ÷ 400 mm
- Width: 140 ÷ 360 mm
- Height: 75 ÷ 300 mm

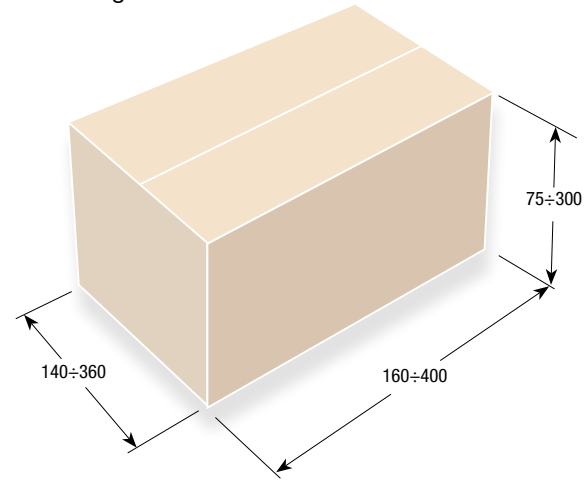

Line dimensions (mm)

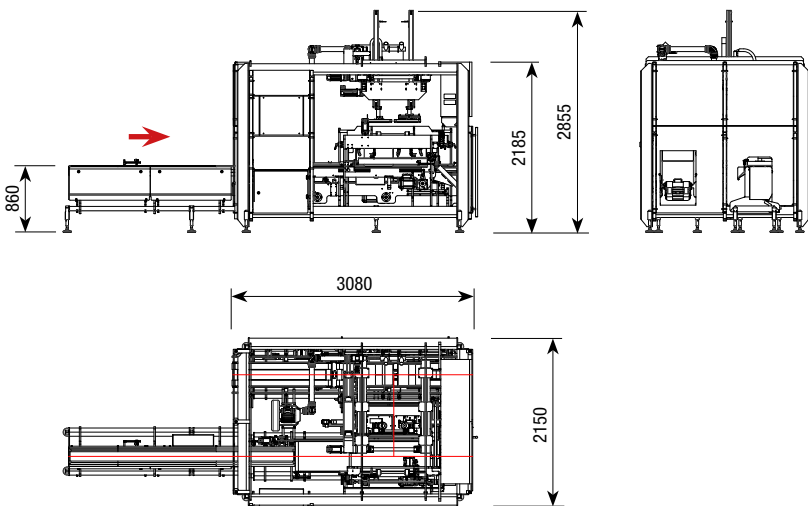

Speed*

Infeed speed up to 120 packs/min

* Minimum and maximum dimensions do not coexist.
The above-mentioned data aren't binding. We have the right to change the specifications of the products without notice.



Headquarters in Prato Sesia - Italy



Cavanna S.p.A. - Headquarters, Prato Sesia - Italy
www.cavanna.com - sales@cavannagroup.com

Cavanna S.p.A. - Mappano - Italy
www.cavanna.com - sales@cavannagroup.com

Cavanna Ltda - Máquinas e Sistemas para Embalagens - Brazil
www.cavanna.com - vendas@cavannagroup.com

Cavanna Packaging USA Inc. - USA
www.cavanna.com - cavanna.usa@cavannagroup.com

Cavanna **is** flowpack, Cavanna **is** cartoning.